



EGOĒ

Značka Egoé vznikla z přirozené lidské touhy – udělat si něco pro sebe. Jediným zadáním bylo uspokojit své vlastní uživatelské a estetické potřeby. Myslet taky jednou i na někoho jiného, než na ostatní.

EN Egoé originated from our natural desire to create something both aesthetic and useful. For once – something more for ourselves, rather than for others.

DE Die Marke Egoé entstand durch die natürliche menschliche Leidenschaft – etwas für sich selber zu erstellen. Die einzige Aufgabe war die Bedürfnisse der Benutzer, der Ästhetik und der von sich selber zu befriedigen. Einmal auch an jemanden anderen als an sich selber zu denken.

PL Marka Egoé powstała z naturalnej ludzkiej chęci zrobienia czegoś dla siebie. Jedyńm zadaniem było zaspokojenie własnych i estetycznych potrzeb. Pomyśl o kimś innym niż Ty sam.

Alva	4
Axis	10
Back to fire	14
Barka	18
Bistrot	22
Bistrot bar	28
Cabra	32
Cora	38
Desa	44
Jelen	48
Laso	52
Laurede	58
Leva	62
Limpido	70
Máj	74
Mario	78
Mini Vera	82
Moja	86
Preva	92
Radium	98
Salto	104
Sena	108
Sombra	112
Spulka	116
Štok	120
Tina	126



design
David Karásek
Radek Hegmon

LAL417

Alva





LAL455



LAL415



LAL456, LAL327

design
David Karásek
Radek Hegmon

LA125

Axis





LA540, LA155



LA155

design
Atelier Pelcl

GRL103

Back to fire





Barka

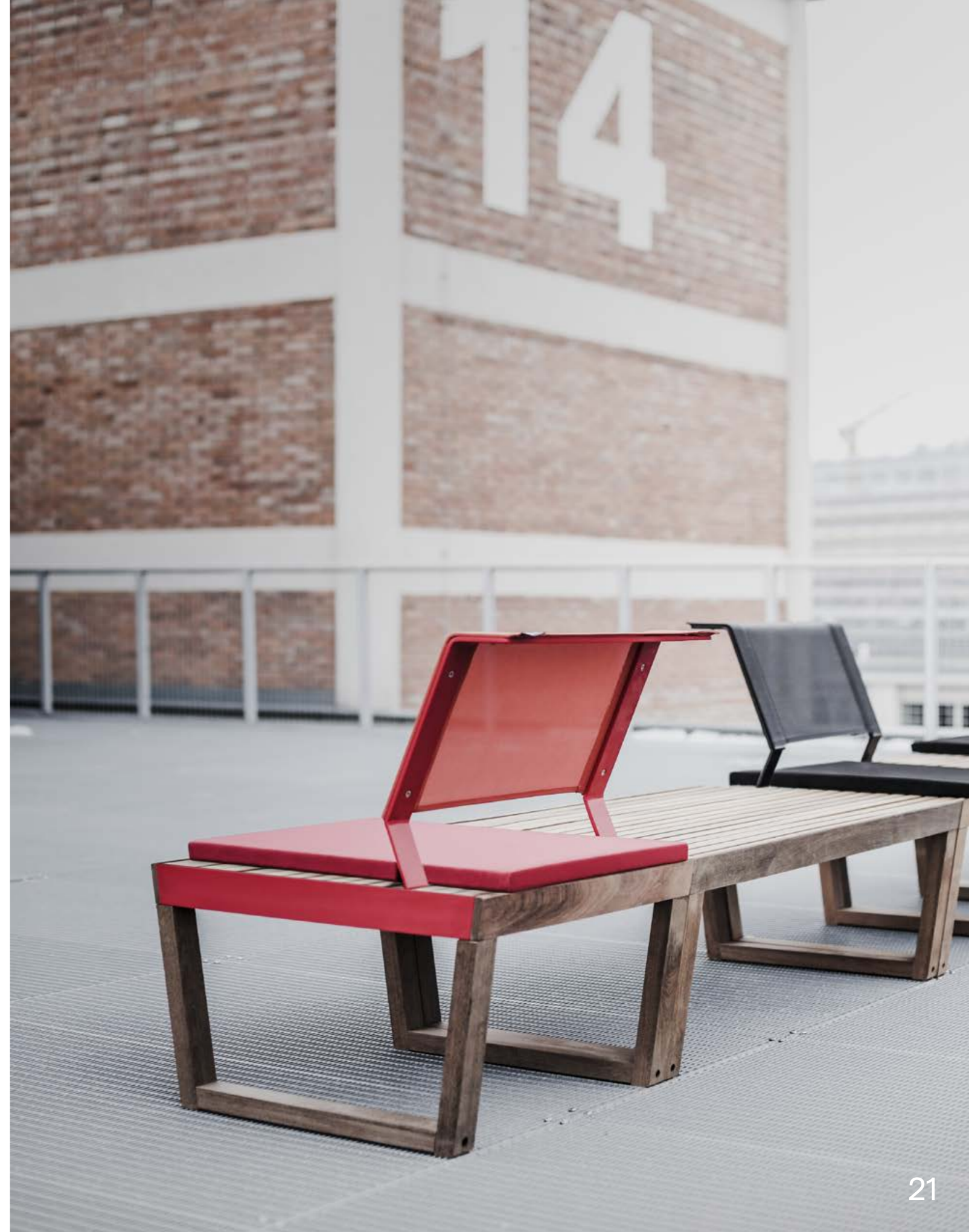



BA110, BA112, BA113, EDO051



BA112, BA113, BA125, EDO050, EDO051

design
David Karásek
Radek Hegmon

LBS230

Bistrot

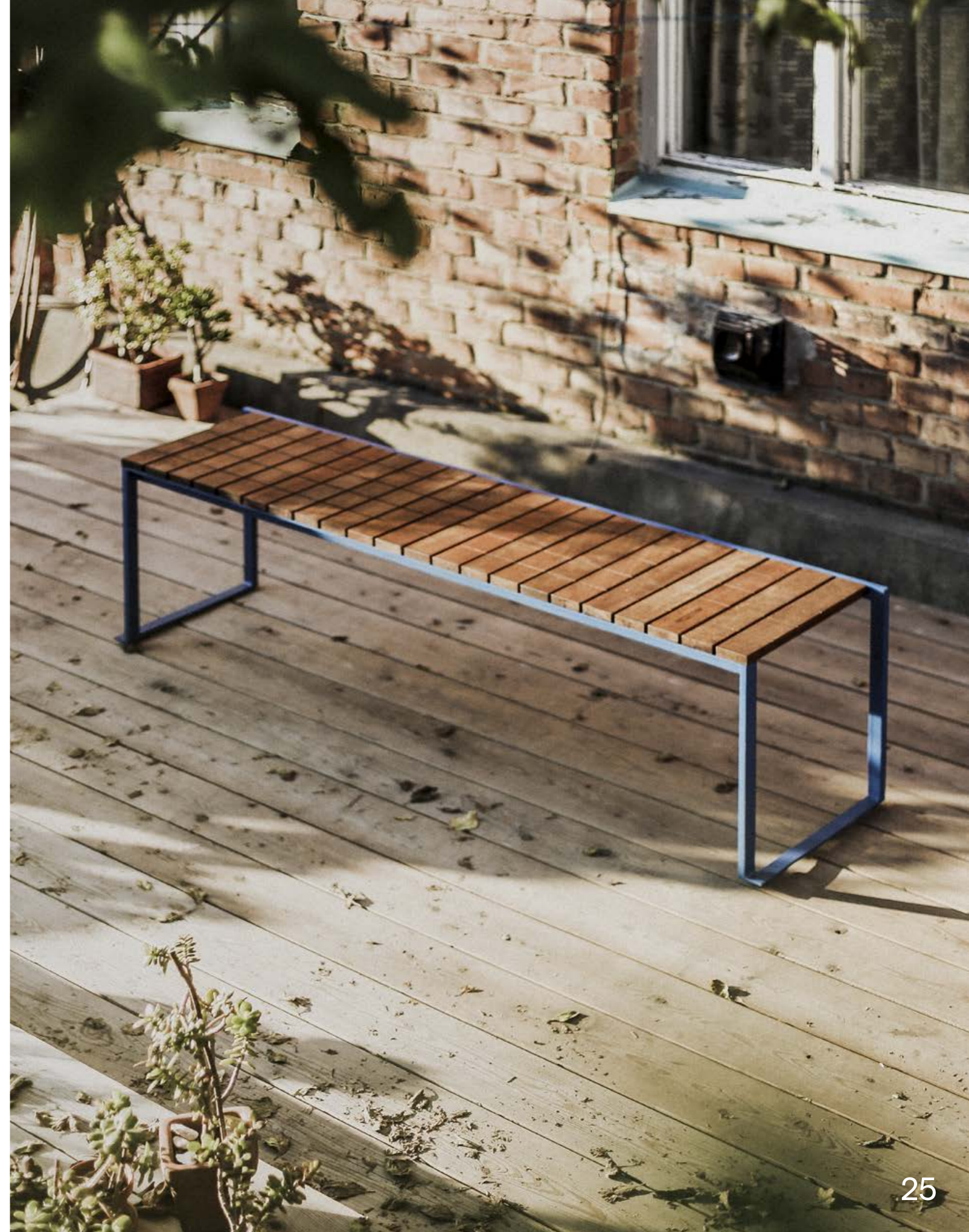



LBS215 EDO041



LBS210



LBS210, LBS620



LBS230, LBS630

design
David Karásek
Radek Hegmon

LBS920, LBS180

Bistrot bar





LBS920, LBS180



LBS920, LBS180

Cabra





ANT300



ANT300



ANT300



ANT305

Cora





LCR125, LCR126



LCR125



LCR125, LCR615



LCR127

Desa

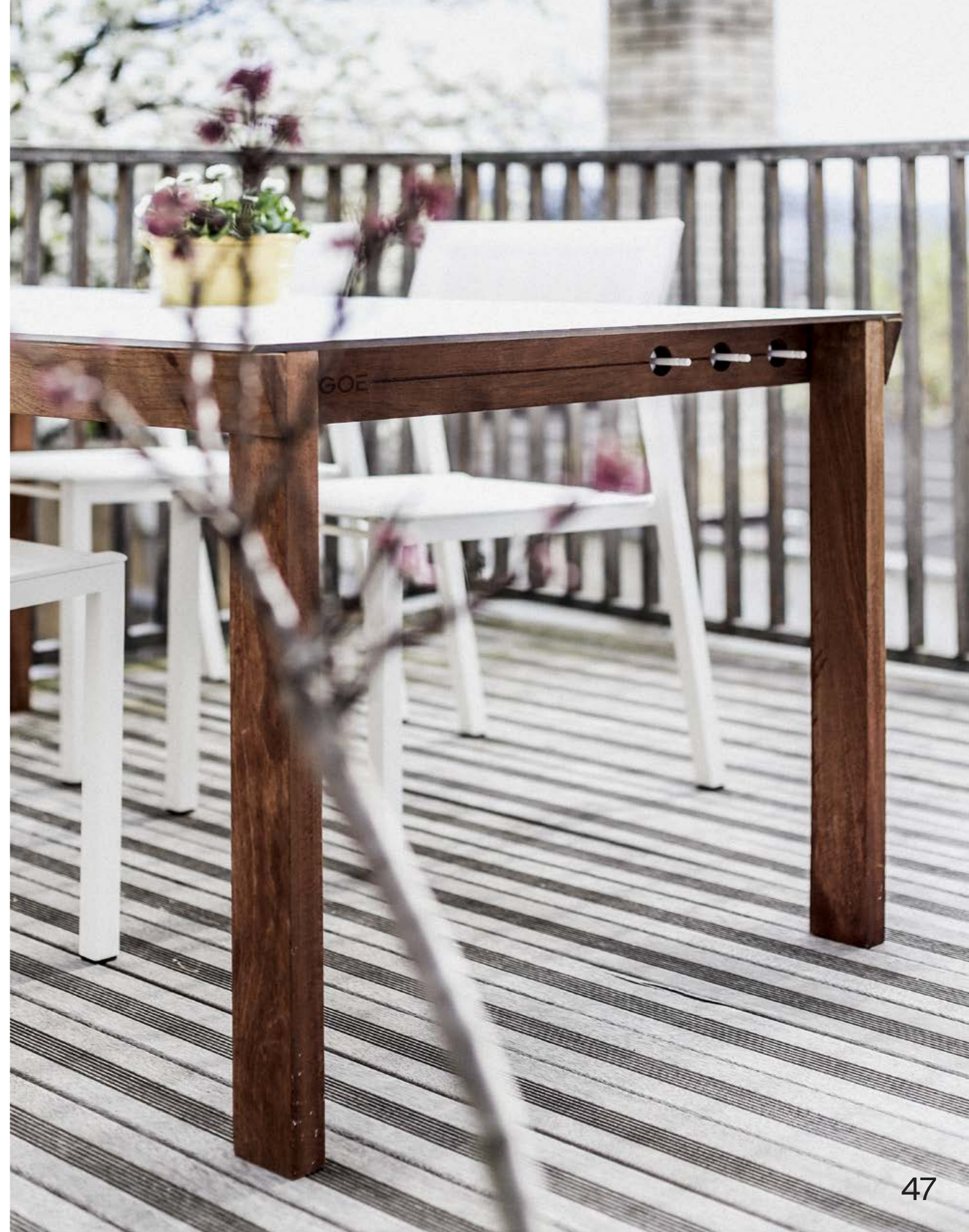



DE100



DE101

Jelen

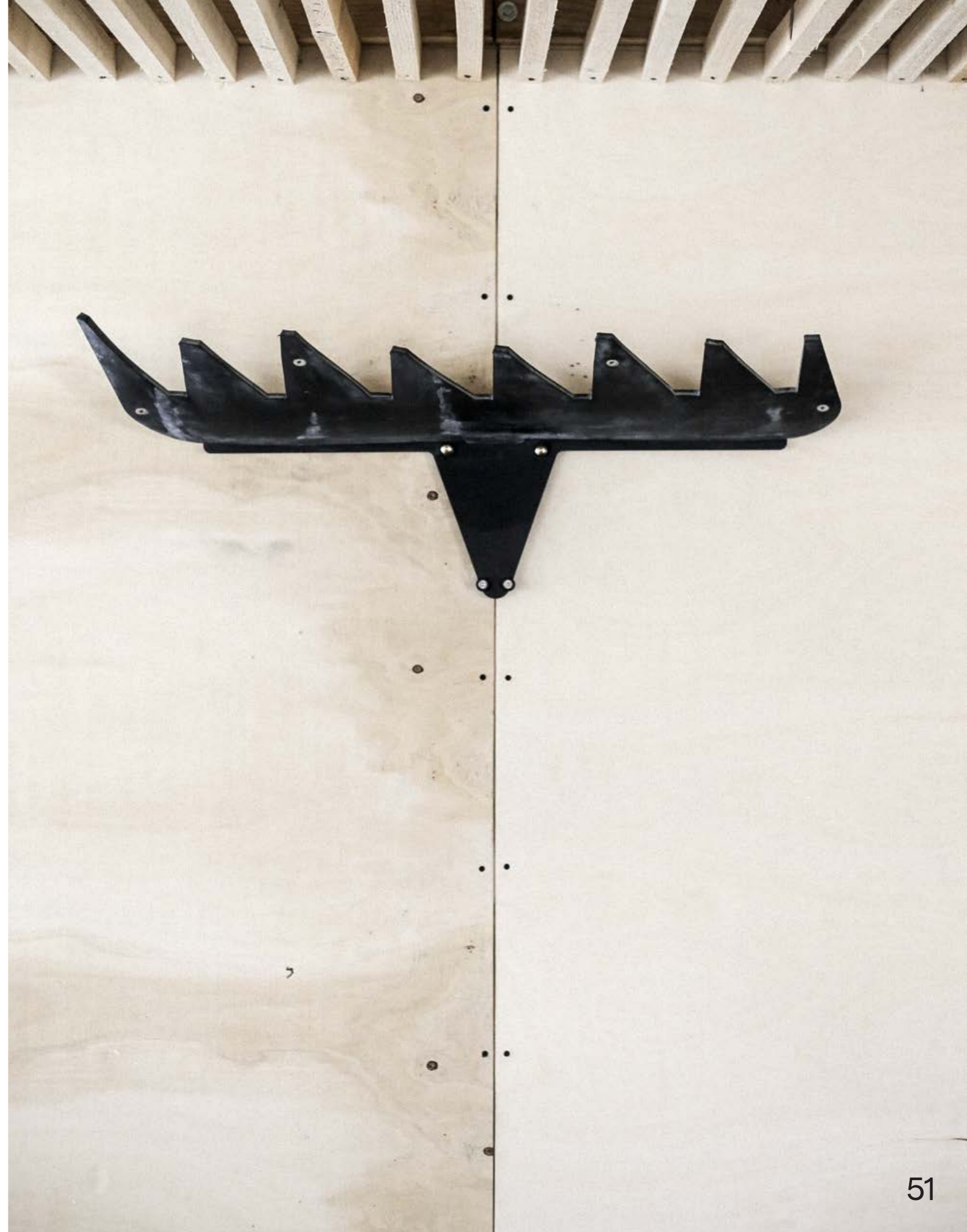



ANT600

Laso

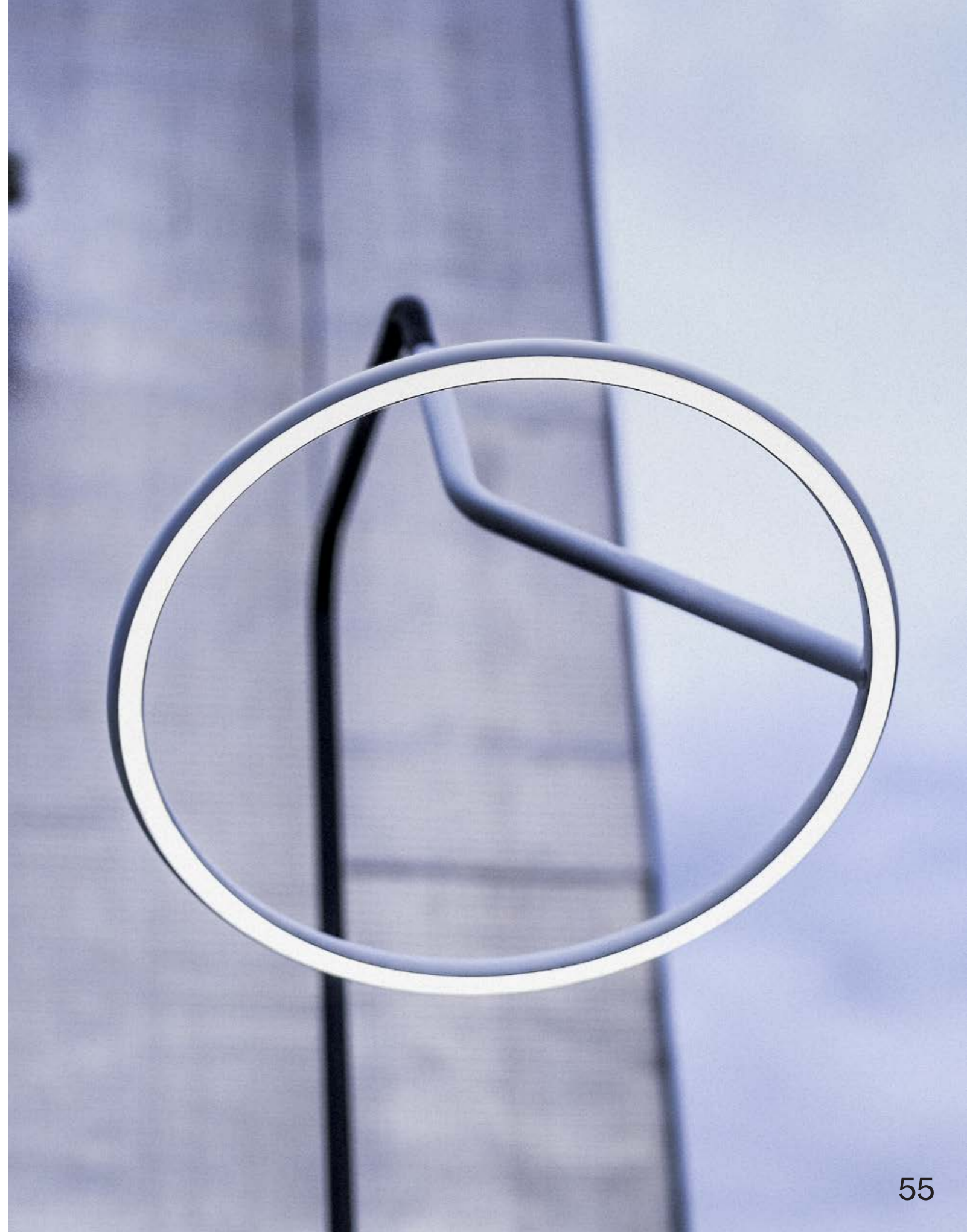



LAS100



LAS101



LAS100, LAS101

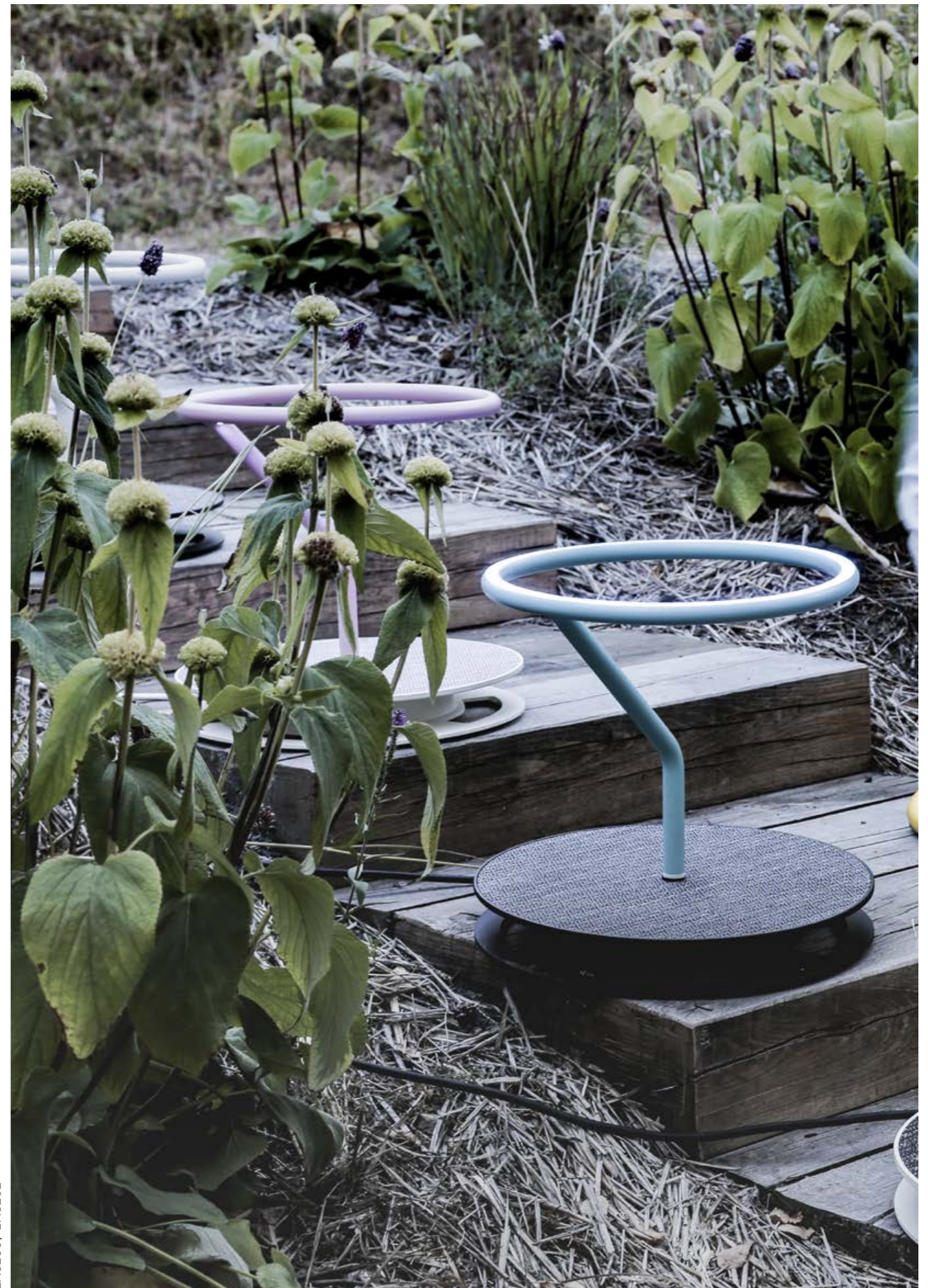

LAS100, LAS101

design
Ruud van Eggelen

LU240

Laurede





LU140, LU240



LU240, LU530

design
studio®¹®²
Luděk Del Maschio

Leva

LEV200, LEV210, LEV300, LEV420, LEV500





LEV110, LEV300



LEV110, LEV300



LEV110, LEV410, LEV430



LEV130, LEV200, LEV210, LEV500



LEV200, LEV210, LEV300, LEV410, LEV420, LEV500



LEV210, LEV300, LEV420, LEV500

design
Roman Vrliška

LLP156

Limpido





LLP105, LLP135



LLP105, LLP135

design
Atelier Pelcl

MA102, MA105, EDO100, EDO101

Máj





MA100, MA102, MA103, MA105, MA106, EDO100, EDO101, EDO102

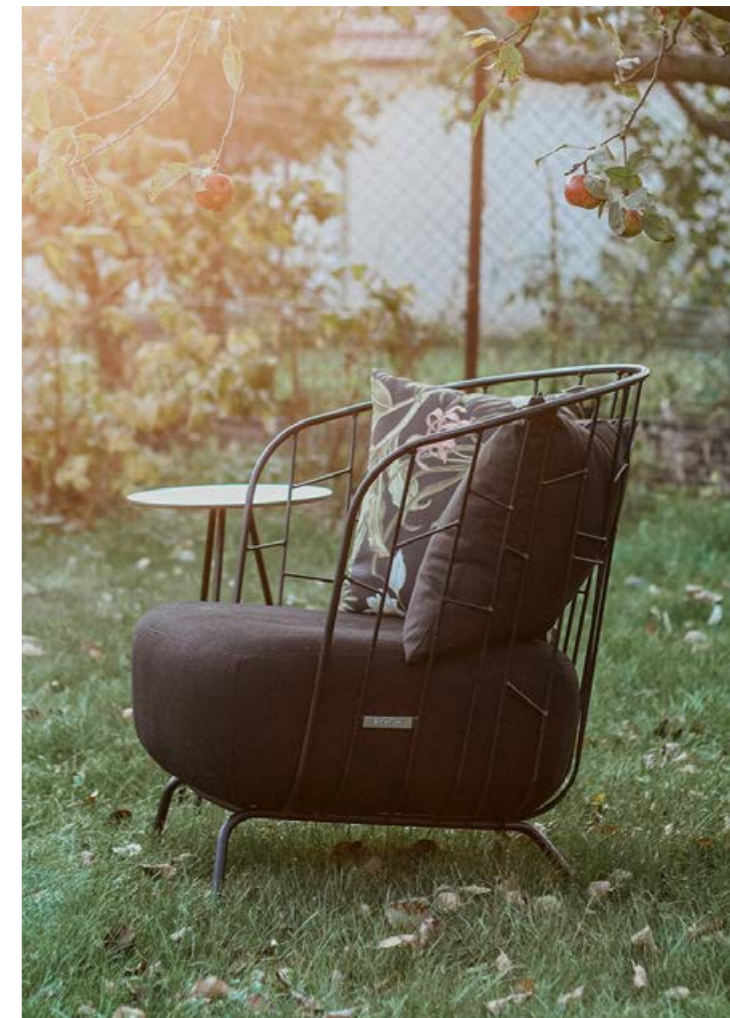

MA102, MA103, EDO101

Mario





MAR220

design
David Karásek
Radek Hegmon

LVE162, LVE930

Mini Vera





LVE150



LVE162, LVE930

Moja



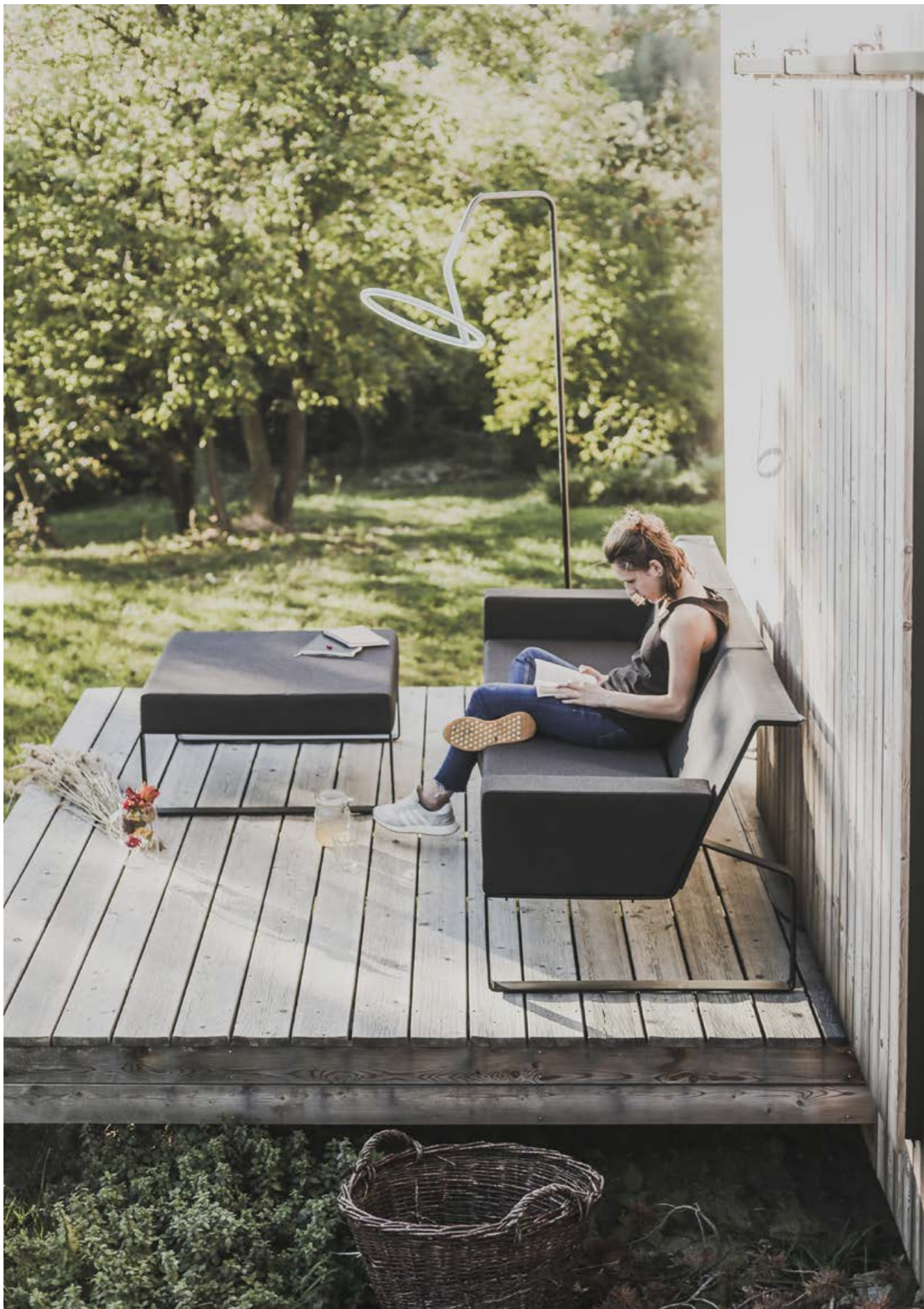

MO130, MO210



MO1201



MO117, MO1301, MO210, MO300, EDO060



MO1301

Preva

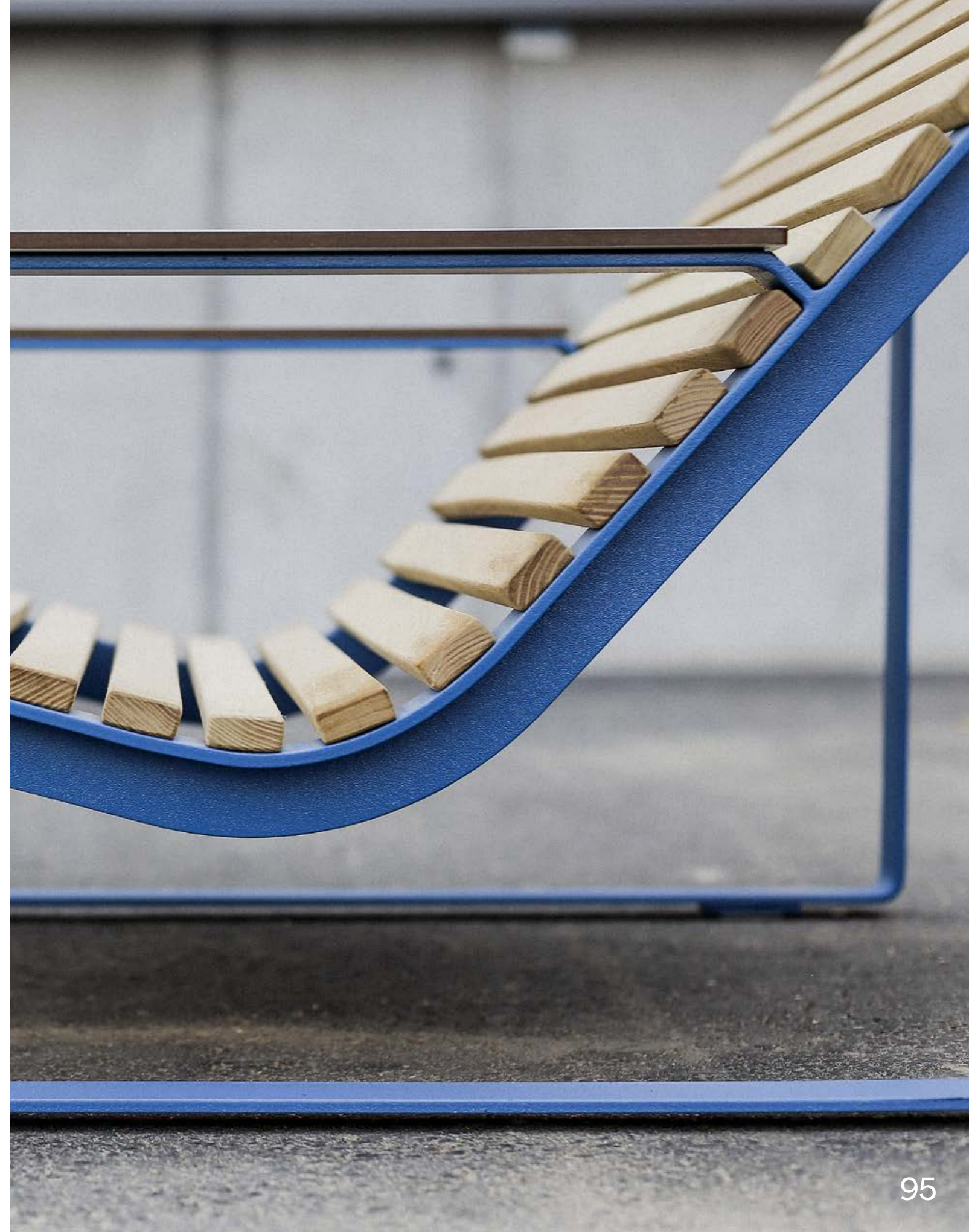

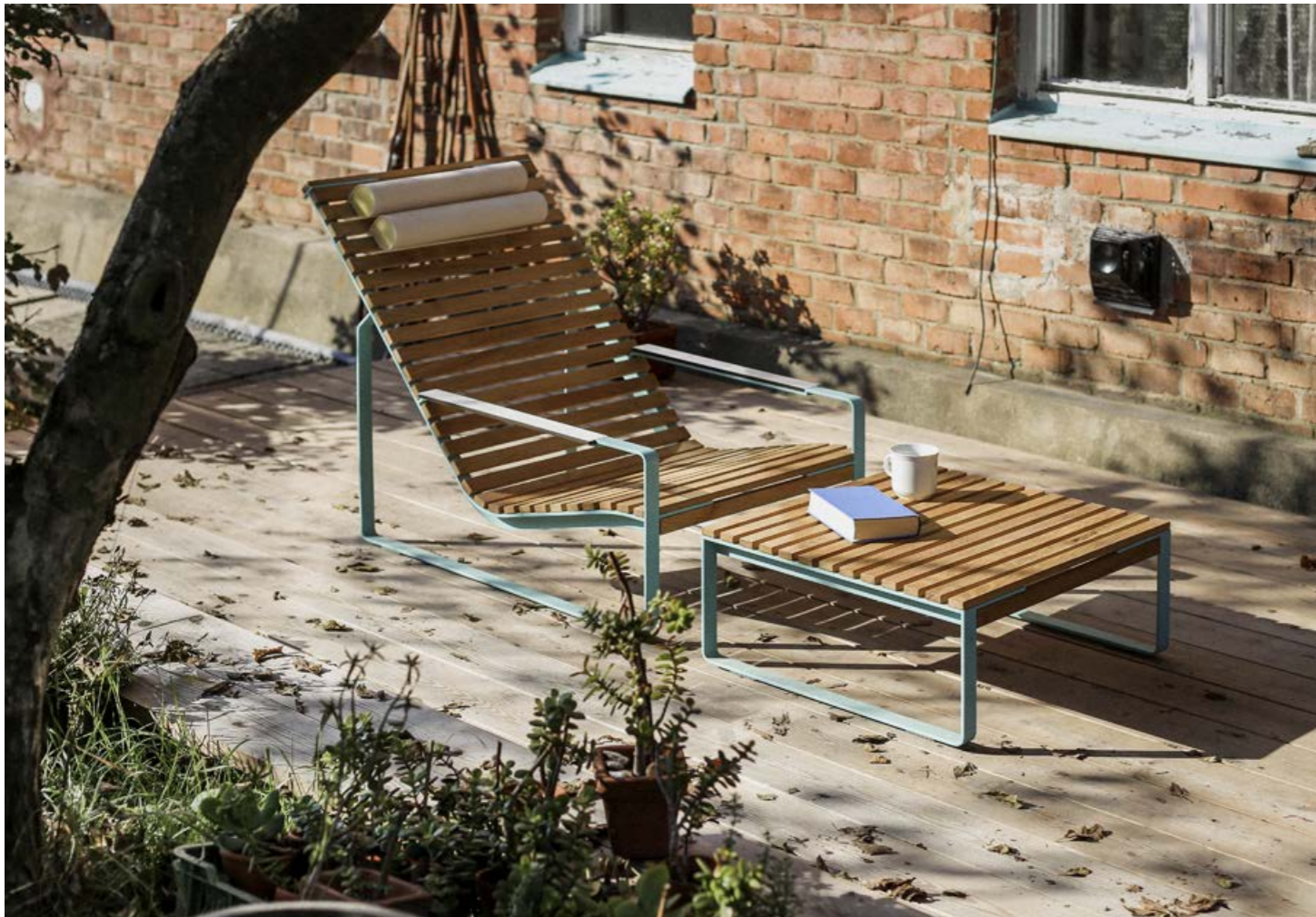

LP355, LP365, EDO011



LP375



LP355, LP365, EDO011

design
David Karásek
Radek Hegmon

LRE350

Radium







LRE115, LRE350

design
studio®¹®²
Jitka Trčková

SAL100

Salto





SAL200



SAL100

Sena





SN100



SN105

Sombra

SOD110, SOD200, SOD410, SOD700

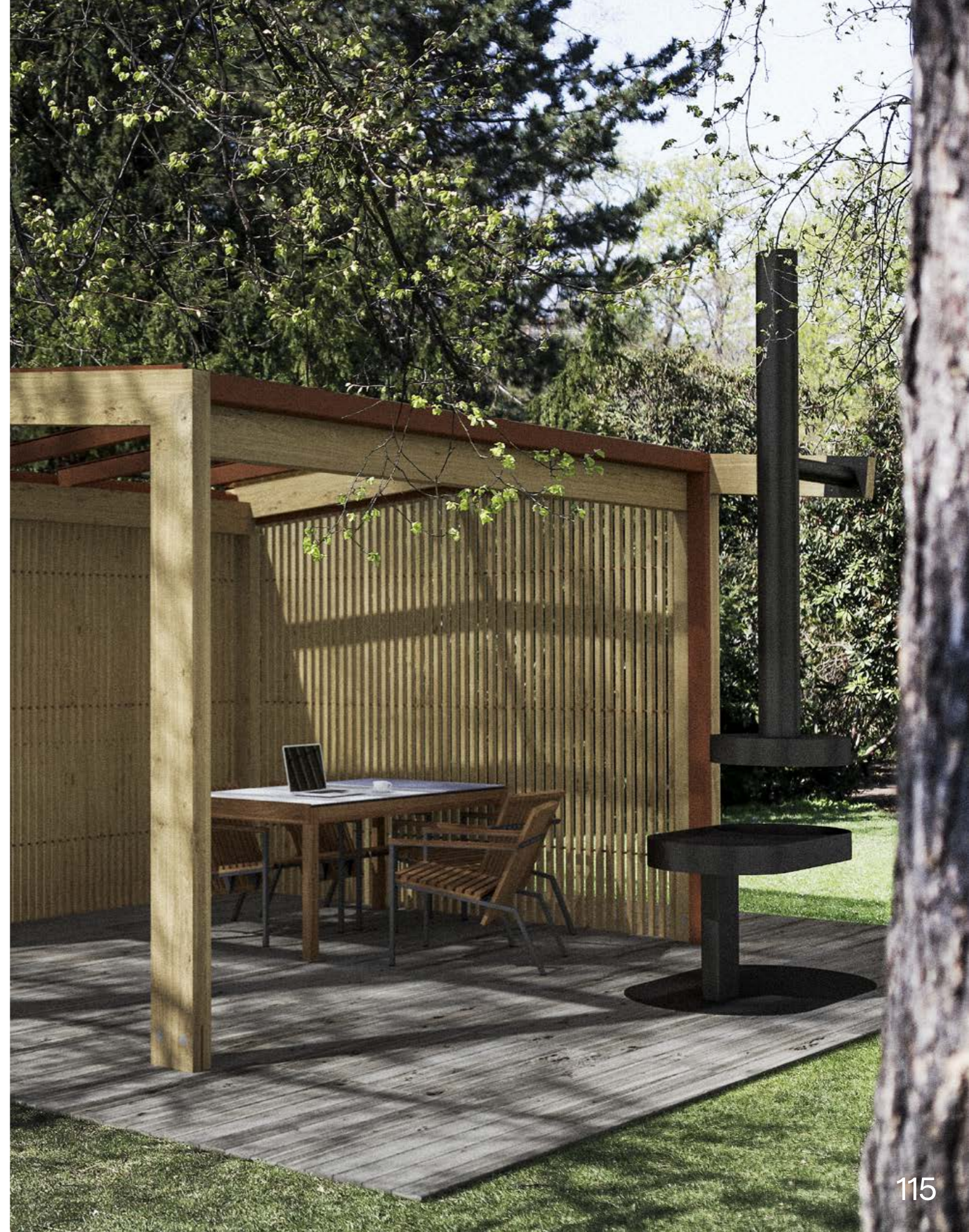

SOD130, SOD200, SOD430, SOD600



Spulka





SP110



SP310

design
Dan Golík

STK230

Štok

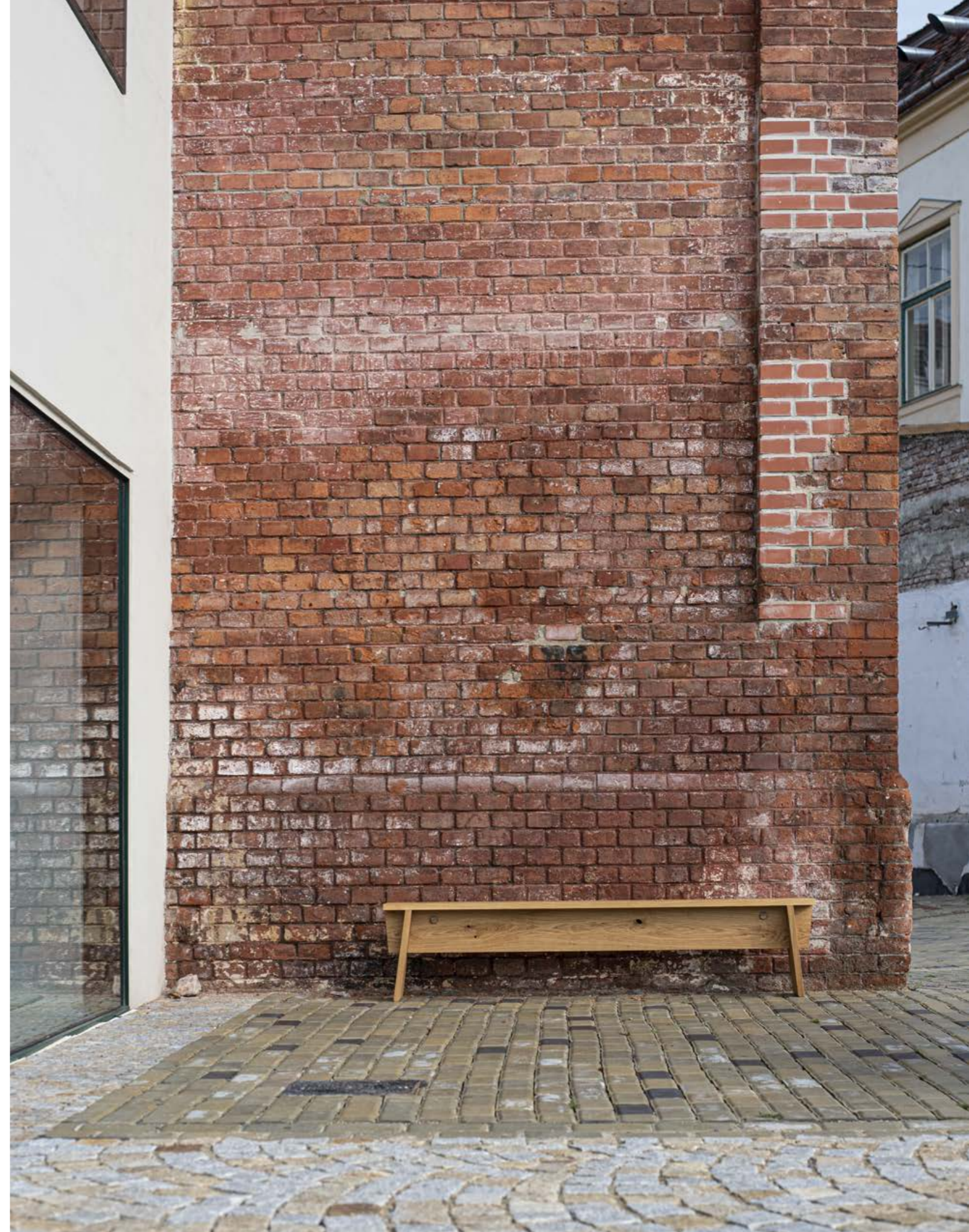



STK110

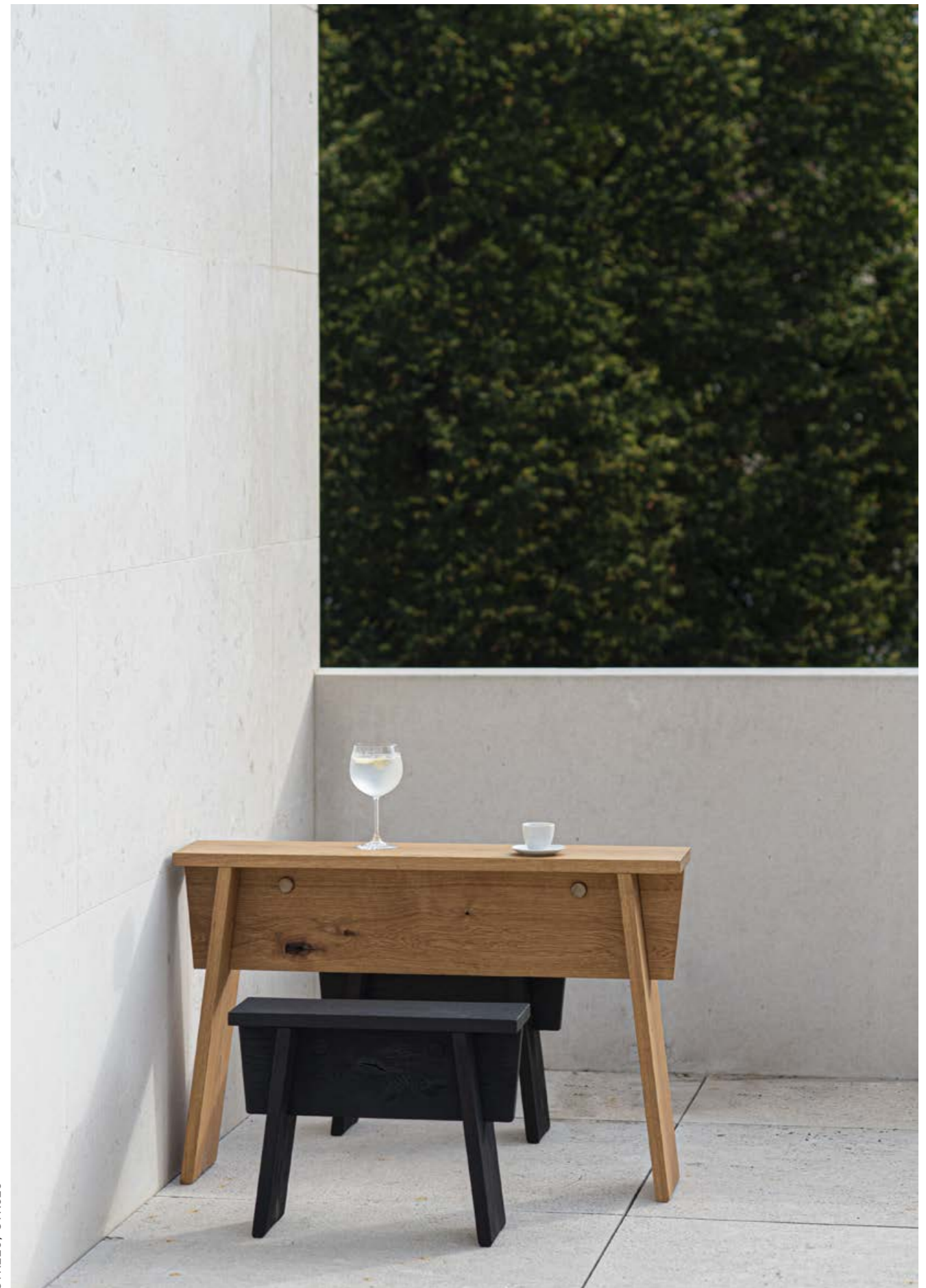

STK120, STK610



STK110, STK120, STK220, STK620

STK210, STK620

Tina





KL105, EDO021



KL104



KL100, KL106





EDO100, EDO101

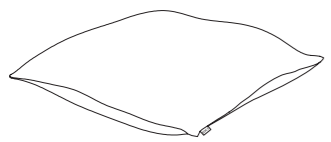

EDO100 55 × 55 cm

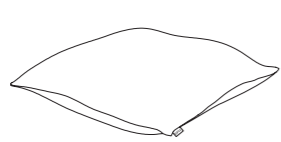

EDO101 43 × 43 cm

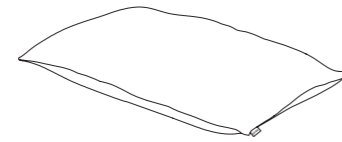

EDO102 60 × 40 cm



EDO202

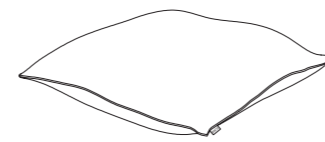

EDO200 55 × 55 cm

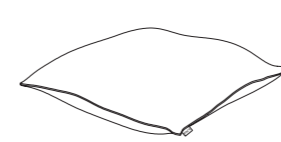

EDO201 43 × 43 cm

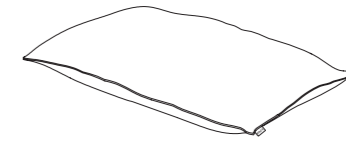

EDO202 60 × 40 cm



EDO303



EDO300, EDO304

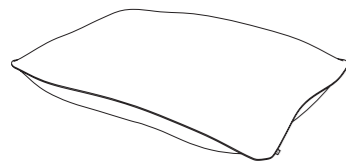

EDO300 160 x 140 cm



EDO301 70 x 70 cm

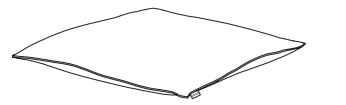

EDO302 45 x 45 cm

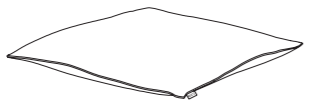

EDO303 45 x 45 cm

s protiskluzem
with antislip
mit Anti-Rutsch
z antypoślizgiem

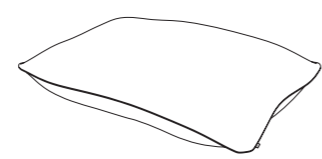

EDO304 140 x 120 cm

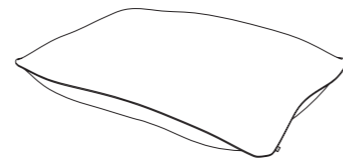

EDO305 120 x 100 cm

Alva

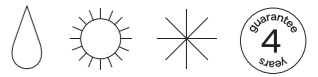

CZ Hliníková konstrukce je povrchově dokončena práškovou barvou. Sedací a ležací část je vyrobena ve variantách z masivu nebo outdoorové síťoviny Batyline. Nábytek je stohovatelný a díky své lehkosti je zaručena dobrá manipulace.

EN Aluminum structure with powder coating finish. The sitting and lying part is made from solid wood or the Batyline outdoor fabric. The products are stackable. The light structure ensures easy manipulation.

DE Die Konstruktion aus Aluminium wurde oberflächlich mit Pulverfarbe beschichtet. Der Sitz- und Liegeteil wird in den Varianten aus Massivholz oder Outdoor- Geflechte aus Batyline hergestellt. Die Möbelstücke sind stapelbar und dank ihrer Leichtigkeit ist eine leichte Manipulation gesichert.

PL Proszkowana aluminiowa konstrukcja. Część do siedzenia i leżenia wykonana jest z litego drewna lub tkaniny zewnętrznej Batyline. Produkty można układać jeden na drugim. Lekka struktura zapewnia łatwe używanie.

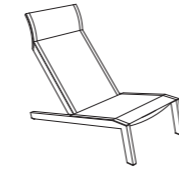

LAL317 59 x 109,5 x 82,5 cm



LAL327 59 x 109,5 x 82 cm

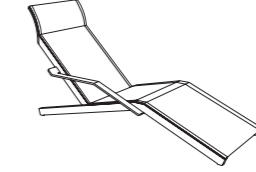

LAL457 64 x 159 x 79 cm

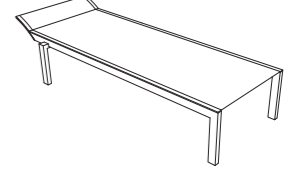

LAL417 76 x 195 x 45 cm



LAL315 59 x 108 x 83 cm



LAL325 59 x 108 x 83 cm



LAL455 64 x 158 x 79,5 cm

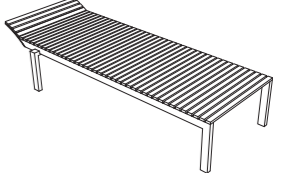

LAL415 76 x 195 x 46 cm

Axis

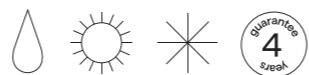

CZ Konstrukce je vyrobena z pozinkovaných ocelových profilů, které jsou povrchově dokončeny práškovou barvou. Sedací část je vyrobena z lamel tropického dřeva nebo akátu. Židle, křesla i lavice lze stohovat.

EN Structure made of galvanized steel profiles with powder coating finish. Seating is made from tropical wood or acacia slats. Chairs, armchairs and benches are stackable.

DE Die Konstruktion wurde aus verzinkten Stahlprofilen hergestellt, welche mit Pulverfarbe beschichtet wurden. Die Sitzfläche besteht aus tropischen Holzlamellen oder Akazienholzlamellen. Die Stühle, Tische sowie Bänke sind stapelbar.

PL Konstrukcja jest wykonana z ocynkowanych profili stalowych, które dodatkowo są malowane proszkowo. Część siedziska wykonana jest z drewna tropikalnego lub akacji. Krzesła, fotele i ławki można ustawiać jeden na drugim.



LA125 50 × 67 × 87 cm



LA135 57 × 67 × 87 cm



LA155 67 × 72 × 76 cm



LA245 120 × 72 × 76 cm



LA540 111,5 × 42,5 × 42 cm

Back to fire

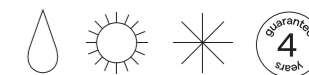

CZ Ohniště i grily jsou vyrobeny z oceli, která je povrchově dokončena žáruvzdornou barvou. Nohy grilů, boční police i madla roštů jsou z akátu. Grilovací rošty jsou vyrobeny z nerez. Kotlíkový set se skládá z ocelové trojnožky, litinového kotlíku a smaltované pokličky.

EN Fire pits and grills are made of steel with a refractory coating. Grill legs, side shelves and grate grips are made of acacia wood. Grill grids are made of stainless steel. The pot set consists of a steel tripod, a cast iron kettle and enamel lid.

DE Die Feuerstellen und die Grille sind aus Stahl, welcher oberflächlich mit feuerfester Farbe behandelt wurde. Die Beine der Grille, die Seitengestelle und die Griffe der Roste sind aus Akazienholz. Die Grillroste sind aus Edelstahl. Das Kessel-Set besteht aus einem Dreibein aus Stahl, einem gusseisernen Kessel und einem emaillierten Deckel.

PL Paleniska i grille są wykonane ze stali z wykończeniem żaroodpornym. Nogi do grilla, półki boczne i uchwyty rusztu są z drewna akacji. Garnki do palenisk składają się ze stalowego statywu, żeliwnego kocioła i emaliowanej pokrywki.

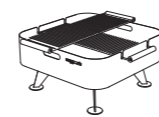

GRL100 70 × 70 × 33 cm

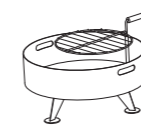

GRL101 Ø 61 × 40,5 cm



GRL102 99,5 × 41 × 69,5 cm

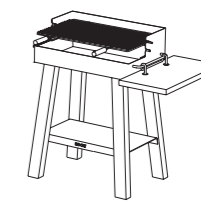

GRL103 101 × 66,5 × 92,5 cm

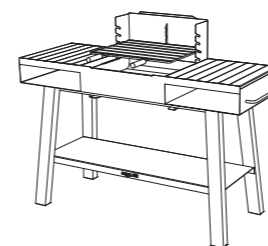

GRL104 152 × 54,5 × 115 cm

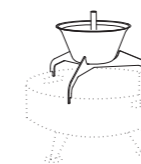

GRL105 55 × 55 × 36 cm

objem kotlíku 7,2 l
kettle volume 7,2 l
Kesselvolumen 7,2 l
pojemność czajnika 7,2 l

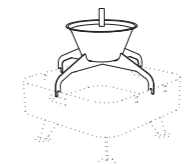

GRL106 62 × 62 × 40 cm

objem kotlíku 7,2 l
kettle volume 7,2 l
Kesselvolumen 7,2 l
pojemność czajnika 7,2 l

Barka

CZ Modulární kolekce Barka je kombinací ocelové a dřevěné konstrukce ve variantách tropického dřeva, nebo akátu. Ocelové díly jsou pozinkovány a povrchově dokončeny práškovou barvou. Opěradlová část je vyrobena ze síťoviny Batyline. Stoličky Barka nabízíme ve dvou provedeních – dřevěné lamely, nebo exteriérová síťovina Batyline. Snímatelné područky a čalounění jsou vyrobeny z kvalitních outdoorových materiálů.

EN The Barka modular collection is a combination of steel and wood constructions available in two variations: tropical wood and acacia. The steel components are galvanized, and finished with a powder coating. The backrest is made of Batyline outdoor mesh, the seat can be made of either wooden slats or Batyline mesh. The removable armrests and upholstery are made of high-quality outdoor material.

DE Die modulare Kollektion Barka ist eine Kombination aus einer Stahl- / und Holzkonstruktion in Ausführungen in tropischem- / oder Akazienholz. Die Stahlteile sind verzinkt und pulverbeschichtet. Die Lehnteile sind aus dem Outdoor-Netzgewebe Batyline Material hergestellt. Die Barka-Stühle werden in zwei Ausführungen angeboten – aus Holzlamellen oder aus Batyline. Die abnehmbaren Armlehnen und Polsterung bestehen aus hochwertigen Outdoor-Materialien.

PL Modułowa kolekcja Barka to połączenie konstrukcji stalowej i drewnianej w wariantach z drewna tropikalnego lub akacji. Części stalowe są ocynkowane i pomalowane proszkowo. Oparcie wykonane jest z siatki Batyline. Krzesła Barka są dostępne w dwóch wersjach – drewniane listwy lub siatki Batyline. Wyjmowane podłokietniki i tapicerka wykonane są z wysokiej jakości materiałów zewnętrznych.

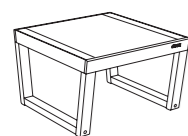
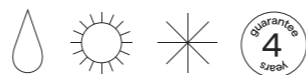

BA111 67 × 69 × 42 cm

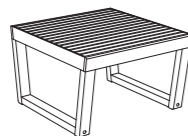

BA112 67 × 69 × 42 cm

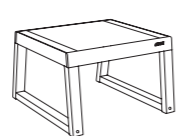

BA113 67 × 67,5 × 42 cm



BA114 67 × 67,5 × 42 cm

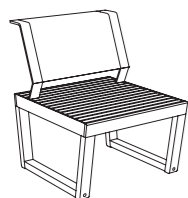

BA110 67 × 72,5 × 83 cm

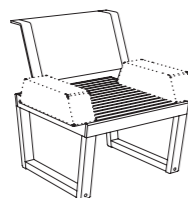

BA115 80 × 72,5 × 83 cm

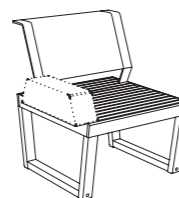

BA116 73,5 × 72,5 × 83 cm

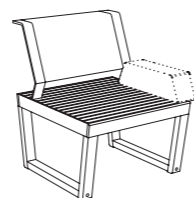

BA117 73,5 × 72,5 × 83 cm

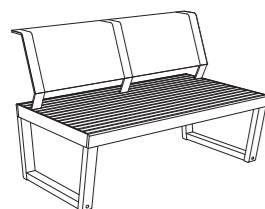

BA120 127 × 72,5 × 83 cm

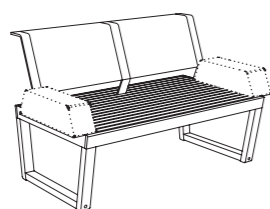

BA125 140 × 72,5 × 83 cm

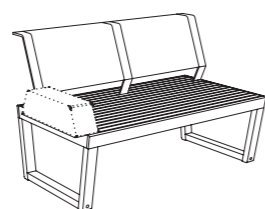

BA126 133,5 × 72,5 × 83 cm

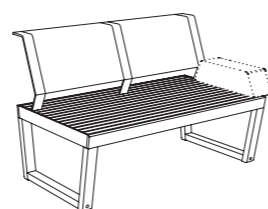

BA127 133,5 × 72,5 × 83 cm

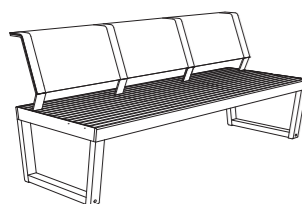

BA130 187 × 72,5 × 83 cm

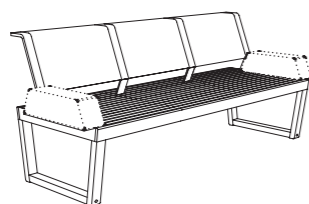

BA135 200 × 72,5 × 83 cm

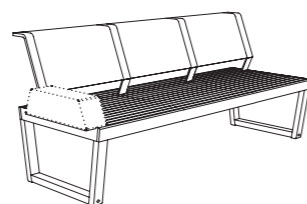

BA136 193,5 × 72,5 × 83 cm

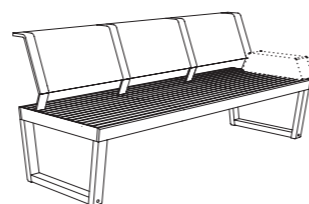

BA137 193,5 × 72,5 × 83 cm

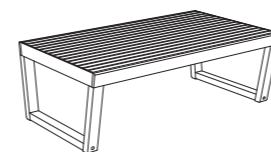

BA122 127 × 69 × 42 cm

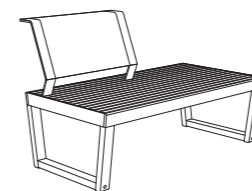

BA128 127 × 72,5 × 83 cm

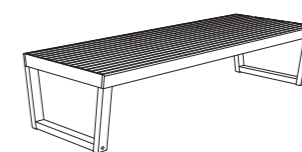

BA132 187 × 69 × 42 cm

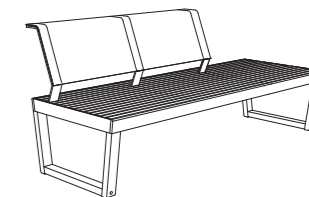

BA138 187 × 72,5 × 83 cm

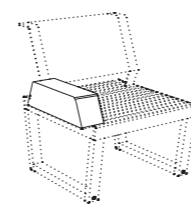

EDO050 14 × 51,5 × 16 cm

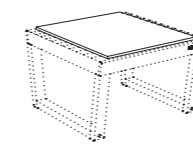

EDO051 54 × 69 × 3 cm

Bistrot

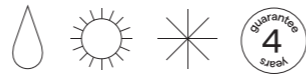

CZ Stoličky, lavice i lehátka jsou stohovatelné. Konstrukce je vyrobena z ocelových pozinkovaných profilů a pásovín, dokončených práškovou barvou. Materiálové varianty jsou tropické dřevo, akát nebo vysokotlaký laminát (HPL).

EN Stools, benches and chairs are stackable. The structure is made from galvanized steel profiles with powder coating finish. Material options: tropical wood, acacia or high pressure laminate (HPL).

DE Die Hocker, Bänke und Liegen sind stapelbar. Die Konstruktion besteht aus verzinkten Stahlprofilen und Stahlbändern, welche mit Pulverfarbe beschichtet wurden. Die Materialauswahl besteht aus tropischem Holz, Akazienholz oder Hochdrucklaminat (HPL).

PL Krzesła, ławki i leżaki można ustawiać jeden na drugim. Konstrukcja wykonana jest z ocynkowanych profili stalowych. Warianty użytych materiałów to drewno tropikalne lub laminat wysokociśnieniowy (HPL).

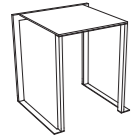

LBS220 43 × 39,5 × 46 cm

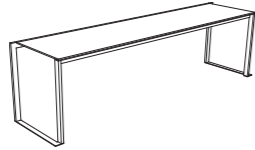

LBS240 165 × 39,5 × 46 cm

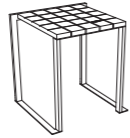

LBS210 43 × 39,5 × 46 cm

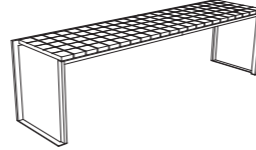

LBS230 165 × 39,5 × 46 cm



LBS610 95,5 × 95,5 × 75 cm

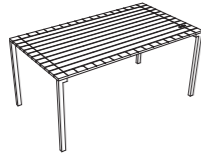

LBS630 166 × 95,5 × 75 cm



LBS410 76 × 188,5 × 45 cm

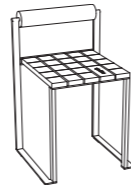

LBS215 43 × 42,5 × 67,5 cm

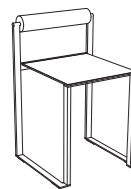

LBS225 43 × 42,5 × 67,5 cm

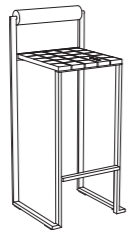

LBS216 43 × 42,5 × 100,5 cm

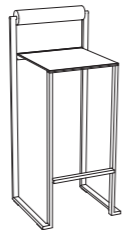

LBS226 43 × 42,5 × 100,5 cm

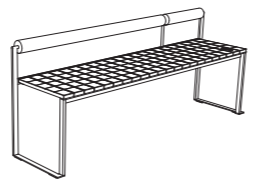

LBS217 165 × 42,5 × 67,5 cm

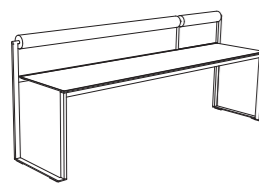

LBS227 165 × 42,5 × 67,5 cm

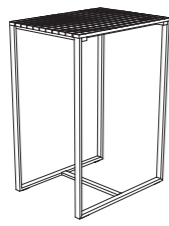

LBS600 80 × 60 × 112 cm

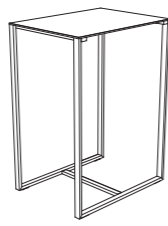

LBS601 80 × 60 × 110 cm

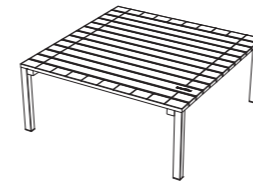

LBS620 95,5 × 95,5 × 40 cm

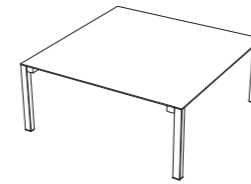

LBS625 95,5 × 95,5 × 40 cm

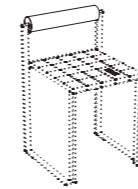

EDO041 Ø 7,5 × 36 cm

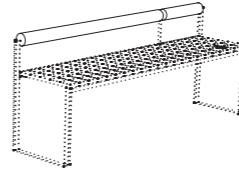

EDO042 Ø 7,5 × 36 + 117,5 cm

Bistrot bar

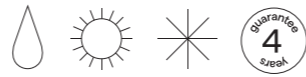

CZ Sedák a stolová deska barového setu jsou vyrobeny z vysokotlakého laminátu (HPL), konstrukce pak z oceli, která je pozinkovaná a povrchově dokončena práškovou barvou.

EN Seat and table top of this bar set are made of high pressure laminate (HPL), the structure is made of galvanized steel with powder coating finish.

DE Die Sitz-/ und Tischplatte dieses Bar- Sets wurde aus Hochdrucklaminat (HPL) hergestellt, die Konstruktion aus verzinktem, mit Pulverfarbe beschichtetem Stahl.

PL Siedzisko i blat wykonane są z laminatu wysokociśnieniowego (HPL), konstrukcja wykonana jest ze stali ocynkowanej i pomalowanej proszkowo.

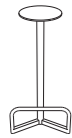

LBS180 31,5 × 36 × 74 cm



LBS920 52 × 52 × 109,5 cm

2-4
😊

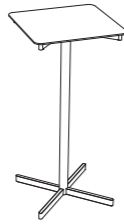

LBS900 52 × 52 × 109,5 cm

2-4
😊

Cabra

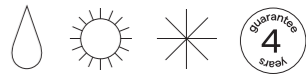

CZ Multifunkční stojan pro lyže a kola s pryžovým hřebenem k bezpečnému odkládání vybavení s kapacitou až 14 párů dospělých lyží a 8 párů dětských lyží. V cyklistické sezóně stojan pojme 10 kol. Pryžový hřeben je nesen áčkovými nohama z masivního dřeva. Stojan lze kotvit a je vybaven ocelovou konstrukcí pro umístění reklamního banneru.

EN Multifunctional outdoor ski and bicycle rack with a rubber edge protector to safely lay equipment with the capacity up to 14 pairs of adult skis plus 8 pairs of kids' skis. During the cycling season, the rack can take up to 10 bicycles. The edge protector is carried by A-shaped legs made of solid wood. The rack can be anchored and is equipped with steel construction for placing an advertising banner.

DE Multifunktionsständer für Ski und Fahrräder mit kammförmigem Halter aus Gummi zum sicheren Ablegen von 14 Paare Erwachsenenskier und 8 Paare Kinderskier. In der Fahrradsaison können bis 10 Fahrräder in den Ständer abgelegt werden. Die Konstruktionsausführung ist in A-Form und besteht aus Massivholz. Der Ständer kann verankert werden und enthält eine Stahlkonstruktion für Werbebanner.

PL Wielofunkcyjny stojak na narty i rowery z gumową uchwytem do bezpiecznego przechowywania sprzętu o pojemności do 14 par nart dla dorosłych i 8 par nart dla dzieci. W sezonie letnim stojak może pomieścić 10 rowerów. Gumowy grzebień jest połączony z solidnymi nóżkami wykonanymi z litego drewna. Stojak można zakotwiczyć w ziemi, a dzięki stalowemu stelażowi ma również przestrzeń na umieszczenie na reklamy.

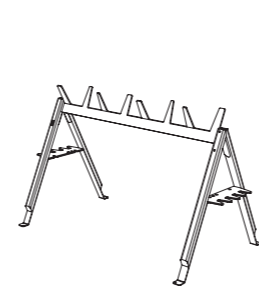

ANT300 260 × 129 × 147 cm

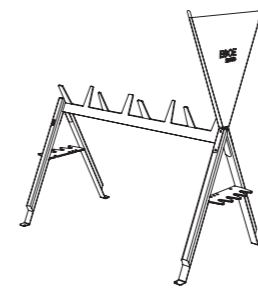

ANT305 260 × 129 × 147/238 cm

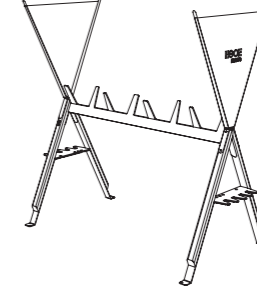

ANT310 260 × 129 × 147/238 cm

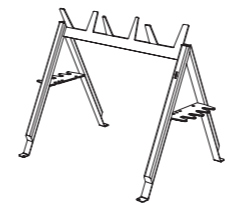

ANT200 200 × 129 × 147 cm

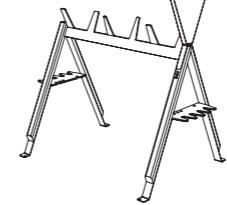

ANT205 200 × 129 × 147/238 cm

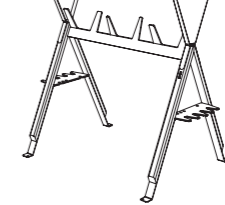

ANT210 200 × 129 × 147/238 cm

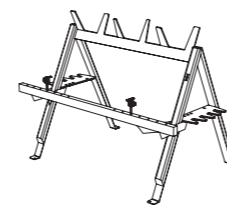

ANT500 200 × 129 × 147 cm

Cora

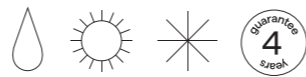

CZ Hliníková konstrukce židlí i stolů je opatřena práškovou barvou. Sedací část židlí vyrábíme ve variantách masiv (tropické dřevo, akát), outdoorová síťovina Batyline nebo vysokotlaký laminát (HPL). Stoly desky můžou být zhotoveny z masivu (tropické dřevo, akát), nebo vysokotlakého laminátu (HPL).

EN Aluminium structure with powder coating finish. Seats made of wood (tropical wood or acacia), outdoor fabric Batyline or high pressure laminate (HPL). Table tops made of tropical wood, acacia or high pressure laminate (HPL).

DE Die Aluminiumkonstruktion der Stühle und Tische ist pulverbeschichtet. Die Sitzfläche der Stühle wird in Ausführungen aus Massivholz (tropisches- oder Akazienholz), Outdoor-Netzgewebe Batyline oder HPL hergestellt. Die Tischflächen können entweder aus Massivholz (tropisches- oder Akazienholz) oder HPL gefertigt werden.

PL Aluminiowa konstrukcja krzeseł i stołów jest pomalowana proszkowo. Krzesła wykonane są z litego drewna (IPE, akacja), siatki zewnętrznej Batyline lub laminatu wysokociśnieniowego (HPL). Blaty mogą być wykonane z litego drewna (IPE) lub laminatu wysokociśnieniowego (HPL).



LCR127 49,5 × 58 × 85 cm



LCR125 49,5 × 58 × 85 cm



LCR120 49,5 × 58 × 85 cm



LCR126 49,5 × 58 × 85 cm



LCR128 49,5 × 58 × 85 cm



LCR225 58,5 × 58 × 85 cm



LCR228 58,5 × 58 × 85 cm



LCR615 86,5 × 86,5 × 76,5 cm



LCR635 174,5 × 86,5 × 76,5 cm

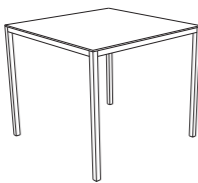

LCR610 86,5 × 86,5 × 76 cm



LCR630 174,5 × 86,5 × 76 cm



LCR620 141,5 × 86,5 × 76 cm



LCR625 141,5 × 86,5 × 76,5 cm

Desa

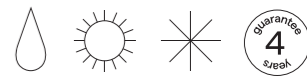

CZ Stoly deska z vysokotlakého laminátu (HPL) je připevněna ke dřevěné konstrukci stolů z tropického dřeva, nebo akátu. Jídelní stoly jsou opatřeny ocelovými háčky, povrchově dokončenými zinkem a práškovou barvou.

EN This high-pressure laminate (HPL) board can be attached to our tropical wood or acacia tables. It is fitted with galvanized steel hooks, which are finished with a powder coating.

DE Die aus Hochdrucklaminat (HPL) hergestellte Tischplatte ist auf eine aus dem tropischen- oder Akazienholz hergestellte Holzkonstruktion fixiert. Die Esstische sind mit Stahlhaken versehen, oberflächlich verzinkt und pulverbeschichtet.

PL Blat wykonany z HPL jest dołączony do drewnianej konstrukcji wykonanej z drewna tropikalnego lub akacji. Wyższe stoly wyposażone są w stalowe haki.

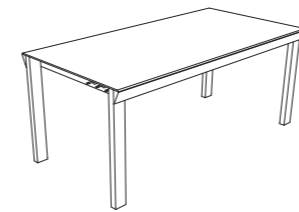

DE100 180 × 95 × 75 cm

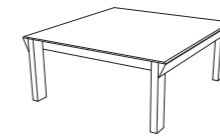

DE101 100 × 100 × 40 cm

44 ←

Jelen

CZ Nástěnný stojan je vyrobený z pryže a oceli, která je opatřena vrstvou zinku a povrchově dokončena práškovou barvou. Pryžová část je k ní připevněna čtyřmi vruty a kapacita stojanu je až 7 párů lyží.

EN Wall-mounted rack organiser is made of rubber and steel with a powder coated finish. The rubber part is attached with four screws and the rack can hold up to seven pairs of skis.

DE Der Wandständer ist aus Gummi und Stahl hergestellt, der zum Schluss pulverbeschichtet wird. Der Gummiteil ist dazu mit vier Schrauben befestigt und die Ständerkapazität beträgt bis zu 7 Paar Skier.

PL Stojak ścienny wykonany jest z gumy i stali pomalowanej proszkowo. Gumowa część jest przymocowana czterema śrubami, a jego pojemność to aż 7 par nart..

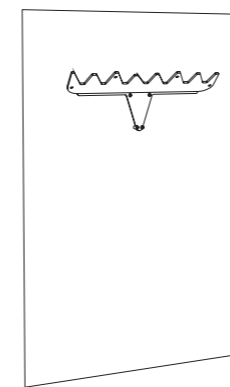

ANT600 97 × 30 × 20 cm

Laso

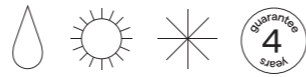

CZ Exteriérové lampy se skládají ze tří částí – základna, nosná tyč a stínidlo. Propojující konektory v jednotlivých částech umožňují modularitu této lampy (vysoká lampa, nízká lampa). Ocelová základna je opatřena zinkem a práškovou barvou, na horní ploše základny je dekorativní outdoorový koberec. Nosná tyč je z nerezové oceli, stínidlo je vyrobeno z hliníku, obě části jsou povrchově dokončeny práškovou barvou. Stínidlo obsahuje LED moduly, které jsou zality v akrylátové pryskyřici. Obě lampy jsou vybaveny 20 metrovým kabelem k zapojení.

EN Our Laso outdoor lamps consist of three parts: a base, a body, and a head. The steel base is galvanized and finished with a powder coating, and its top surface is covered with decorative, outdoor material. The carrier rod is made of stainless steel; the lampshade is made of aluminum; both parts are powder-finished. The head is fitted with LED modules, which are coated with acrylic resin. The lamps have a 20-meter cable allowing them to be powered from a distance, and can be adjusted to two different heights (low and high).

DE Die Außenlampen Laso bestehen aus drei Teilen – dem Lampenfuß, dem Grundgestell und dem Lampenschirm. Die verbindenden Konnektoren in den einzelnen Teilen ermöglichen die Modularität dieser Lampe (stehende oder niedrige Lampe). Der Stahlampenfuß ist verzinkt und pulverbeschichtet, auf der oberen Fläche des Lampenfußes befindet sich ein dekorativer Outdoor-Teppich. Die Tragegestange besteht aus Edelstahl, der Schirm ist aus Aluminium, beide Teile sind pulverbeschichtet. Der Lampenschirm enthält LED-Module, die mit Acrylharz beschichtet sind. Die beiden Lampen sind mit einem 20 Meter langen Außenkabel zum Einschalten ausgestattet.

PL Lampy zewnętrzne Laso składają się z trzech części. Podstawa stalowa jest ocynkowana i pomalowana proszkowo, a jej górna powierzchnia pokryta jest dekoracyjnym materiałem. Pręt nośny jest wykonany ze stali nierdzewnej. Natomiast klosz wykonany jest z aluminium. Obie części są lakierowane proszkowo. Klosz jest dopasowany z modułami LED pokrytymi żywicą akrylową. Lampy mają 20-metrowy kabel, który umożliwia zasilanie z odległości i można go ustawić na dwóch różnych wysokościach (niskiej i wysokiej).

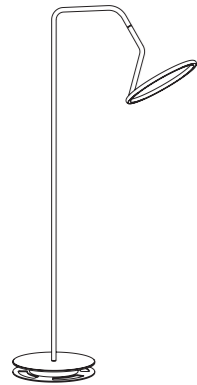

LAS101 Ø 46 × 104 × 204 cm



LAS101 Ø 46 × 46 cm



LAS100 Ø 46 × 190 cm



LAS100 Ø 46 × 46 cm

Laurede

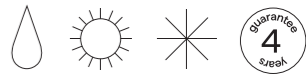

CZ Konstrukce je vyrobena z ocelových pozinkovaných profilů. Povrchová úprava je dokončena práškovou barvou. Sedací část i stolové desky jsou vyrobeny z tropického dřeva.

EN Structure made of galvanized steel profiles with powder coating finish. Seats and table tops made of tropical wood.

DE Die Konstruktion besteht aus verzinkten Stahlprofilen. Die Behandlung der Oberfläche wird mit Pulverfarbe vollzogen. Die Sitz- sowie Tischplatte wurde aus tropischem Holz hergestellt.

PL Stal ocynkowana proszkowo. Blat i siedziska pokryte tropikalnym drzewem.

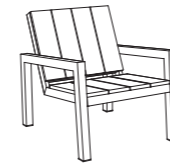

LU140 67,5 × 79 × 75 cm



LU240 125,5 × 79 × 75 cm

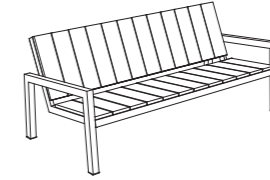

LU250 183,5 × 79 × 75 cm



LU510 48 × 45 × 37,5 cm

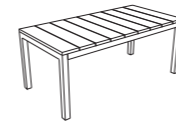

LU530 89,5 × 45 × 38 cm

Leva

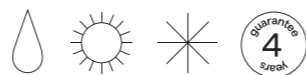

CZ Modulový systém Leva se skládá ze základních modulů a příslušenství. Ocelové díly jsou opatřeny zinkem a práškovou barvou. Nosné trámy, rám postele a podlaha jsou z modřínového dřeva.

- Příslušenství:**
- Ocelový květináč je opatřen odtoky pro přebytečnou vodu.
 - Houpací postel je opatřena boční sítí. Dřevěný rám postele s dřevěným roštem a outdoorovými matracemi je zavěšen na popruzích.
 - Střecha i boční díl jsou vyrobeny z outdoorové nepromokavé textilie nebo outdoorové síťoviny.
 - Ocelový stůl s HPL deskou.
 - Boční i horolezecká stěna s úchyty je vyrobena z outdoorové překližky.
 - Podlaha ve variantách dřeva, nebo pororoštu.
- Jednotlivé příslušenství lze v modulech kombinovat. Jako doplněk lze zvolit outdoorové polštáře.

EN Our Leva modular system consists of a basic module and accessories. All steel parts are galvanized and finished with a powder coating. The supporting beams, the bed frame and the floor are made of larch wood.

- Accessories:**
- The steel pot is fitted with drains for excess water.
 - The bed swing is fitted with side nets, and its wooden frame, grate, and outdoor mattresses are suspended from a harness.
 - The roof and the side panel are made of outdoor waterproof fabric or outdoor mesh.
 - Steel table with an HPL board.
 - The side wall and the climbing wall with climbing holds is made of outdoor plywood.
 - Wooden and grated floors are available.
- The modules allow for addition of various accessories, including outdoor pillows.

DE Das Modulsystem Leva besteht aus Grundmodulen und Zubehör. Alle Stahlteile sind verzinkt und pulverbeschichtet. Die Tragbalken, der Bettrahmen und der Boden bestehen aus Lärchenholz.

- Zubehör:**
- Ein Stahlpflanzenbehälter, der mit Wasserablauf ausgestattet ist.
 - Das Schaukelbett ist mit einem Seitennetz ausgestattet. Der Holzbettrahmen mit einem Holzrost und mit Outdoor-Matratzen ist an den Traggurten aufgehängt.
 - Das Dach und der Seitenteil bestehen aus wasserdichtem Outdoor-Gewebe oder -Netzgewebe.
 - Stahltisch mit HPL-Platte.
 - Die Seiten-/ und Kletterwand mit Griffen bestehen aus wetterbeständigem Sperrholz.
 - Fussboden aus Holz oder Gitterrost.
- Die einzelnen Zubehörteile können in den Modulen kombiniert werden. Als Zubehör können Outdoor-Kissen ausgewählt werden.

PL System modułowy Leva składa się z podstawowych modułów i akcesoriów. Części stalowe są ocynkowane i pomalowane proszkowo. Belki nośne, rama i podłoga wykonane są z drewna modrzewiowego.

- Akcesoria:**
- Konstrukcja stalowa wyposażona jest w odpływ nadmiaru wody.
 - Łóżko bujane jest zabezpieczone boczną siatką.
 - Drewniana rama łóżka wykonana jest z listwy, a materace zewnętrzne zawieszane są na paskach.
 - Dach i panel boczny wykonano z wodoodpornej tkaniny zewnętrznej lub siatki zewnętrznej.
 - Stalowy stół z płytą HPL.
 - Ściana boczna i wspinaczkowa z uchwytami wykonana jest ze sklejki zewnętrznej.
 - Podłoga wykonana jest z drewna.
- Poszczególne akcesoria można łączyć w moduły. Jako akcesorium można wybrać poduszki zewnętrzne.

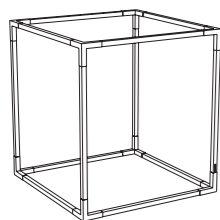

LEV110

222 × 222 × 240 cm

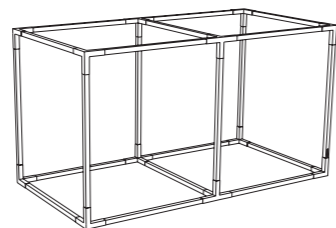

LEV120

436 × 222 × 240 cm

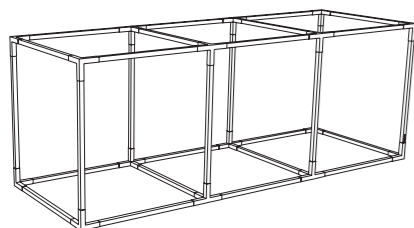

LEV130

650 × 222 × 240 cm

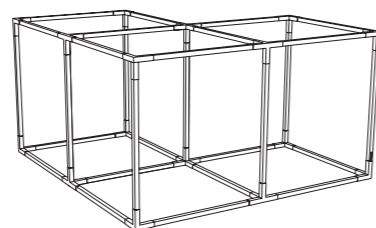

LEV125

436 × 436 × 240 cm

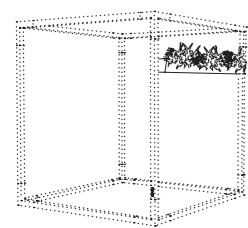

LEV200

206,5 × 19 × 15,5 cm

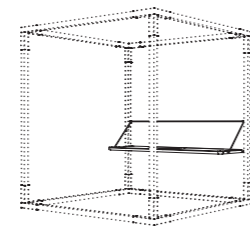

LEV210

206,5 × 58,5 × 44 cm

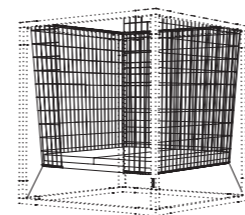

LEV300

178 × 178 × 200/234 cm

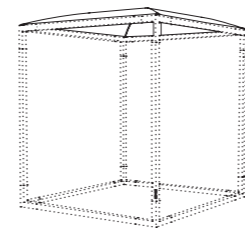

LEV401

214 × 214 × 27 cm

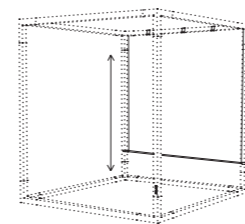

LEV411

206 × 224 × 0,2 cm

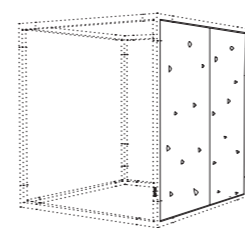

LEV430

206 × 224 × 7 cm

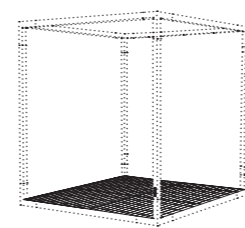

LEV510

207 × 207 × 3/9 cm

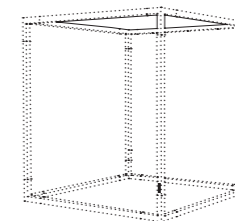

LEV400

207 × 207 × 0,2 cm

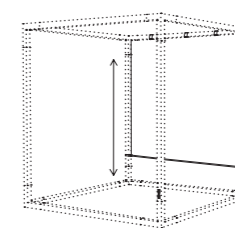

LEV410

206 × 224 × 0,2 cm

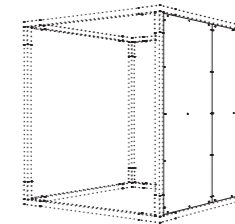

LEV420

206 × 224 × 7 cm

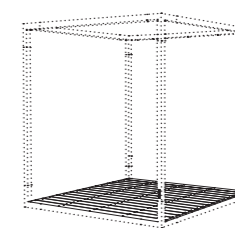

LEV500

207 × 207 × 2,8/10 cm

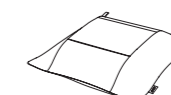

EDO110

43 × 43 cm

určeno pro
designated for
bestimmt für
przeznaczone dla
LEV300

Limpido

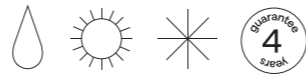

CZ Pozinkovaná ocelová konstrukce je povrchově dokončena práškovou barvou.

EN This galvanized steel construction is finished with a powder coating.

DE Die verzinkte Stahlkonstruktion ist pulverbeschichtet.

PL Ocynkowa proszkowo konstrukcja stalowa.



LLP135 51 × 76 × 81 cm

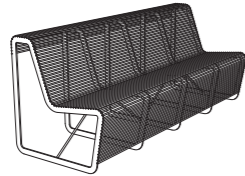

LLP156 200 × 76 × 81 cm



LLP155 150 × 76 × 81 cm

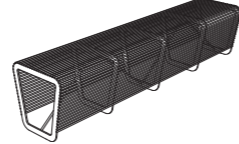

LLP126 200 × 44 × 45 cm

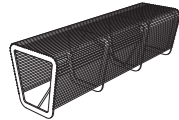

LLP125 150 × 44 × 45 cm

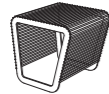

LLP105 51 × 44 × 45 cm

Máj

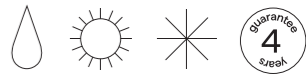

CZ Pozinkovaná ocelová konstrukce je povrchově dokončena práškovou barvou. Snímatelné čalounění včetně polštářů je vyrobeno z vysoce kvalitních outdoorových materiálů. Desky stolků jsou vyrobeny z vysokotlakého laminátu (HPL).

EN This galvanized steel construction is finished with a powder coating. Its upholstery (including the pillows) is made of high-quality, outdoor material, and its table top is made of high pressure laminate (HPL).

DE Die verzinkte Stahlkonstruktion ist pulverbeschichtet. Abnehmbare Polsterungen einschließlich der Kissen wurden aus hochwertigen Outdoor-Materialien hergestellt. Die Tischplatten wurden aus Hochdrucklaminat (HPL) hergestellt.

PL Ocynkowa proszkowo konstrukcja stalowa. Zdejmowana tapicerka w tym poduszki są wykonane z wysokiej jakości materiałów zewnętrznych. Płyty stoły wykonane są z laminatu wysokociśnieniowego (HPL).



MA104 100 × 67 × 32 cm



MA105 Ø 70 × 32 cm



MA106 Ø 70 × 52 cm



MA103 Ø 33 × 55 cm



MA102 77 × 73 × 76,5 cm

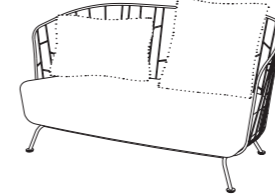

MA100 150 × 76,5 × 78 cm



EDO100 55 × 55 cm



EDO101 43 × 43 cm



EDO102 60 × 40 cm



EDO200 55 × 55 cm



EDO201 43 × 43 cm



EDO202 60 × 40 cm

Mario

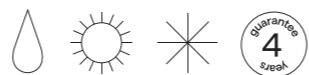

CZ Konstrukce je vyrobena z pozinkovaných ocelových pásovin a plechu, dokončených práškovou barvou. Lamely různých délek nabízíme ve variantě akátu.

EN The structure is made of galvanized steel strips and steel sheets with a powder coated surface finish. We offer slats in various lengths in the acacia variant.

DE Die Konstruktion wird aus verzinkten Stahlstreifen, welche anschliessend noch mit Pulverfarbe beschichtet werden. Die Lamellen der verschiedenen Längen bieten wir im Akazienholz an.

PL Podstawa wykonana z ocynkowanej malowanej proszkowo stali. Listwy o różnych długościach są z akacji.



MAR110 69 × 45 × 98,5 cm

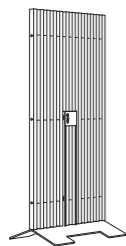

MAR120 69 × 45 × 153,5 cm



MAR130 69 × 45 × 211 cm

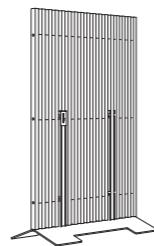

MAR220 99 × 45 × 153,5 cm

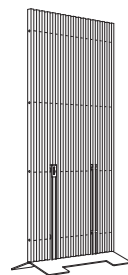

MAR230 99 × 45 × 211 cm

Mini Vera

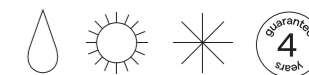

CZ Pozinkovaná ocelová konstrukce je povrchově dokončena práškovou barvou. Sedací část židliček a laviček nabízíme v tropickém dřevě a akátu. Opěradlovou část si můžete zvolit dřevěnou nebo z vysokotlakého laminátu (HPL). Stolové desky stolků jsou vyrobeny z vysokotlakého laminátu (HPL).

EN The zinc-coated steel structure has a powder coated finish. The seats of chairs and benches can be made of tropical wood and acacia. For the backrest part, you can choose from wood or high-pressure laminate (HPL). The table tops are made out of high-pressure laminate (HPL).

DE Die verzinkte Stahlkonstruktion ist mit Pulverfarbe oberflächlich behandelt. Die Sitzfläche des Stuhles und der Bank bieten wir in tropischem Holz oder Akazienholz an. Die Lehne können Sie aus Holz oder aus Hochdrucklaminat (HPL) auswählen. Die Tischplatten werden aus Hochdrucklaminat (HPL) hergestellt.

PL Konstrukcja ze stali ocynkowanej proszkowo. Siedzisko krzesel i ławek wykonane jest z drewna tropikalnego i akacji. Oparcie może być wykonane z drewna lub laminatu wysokociśnieniowego (HPL). Blaty wykonane są z laminatu wysokociśnieniowego (HPL).



LVE150 100 × 47 × 56 cm



LVE152 35 × 47 × 56 cm



LVE160 100 × 47 × 55 cm



LVE162 35 × 47 × 55 cm



LVE920 120 × 70 × 53,5 cm

4-6
😊



LVE930 70 × 70 × 53,5 cm

4
😊

Moja

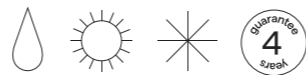

CZ Modulární kolekce Moja je vyrobena z ocelové konstrukce, která je pozinkována a povrchově dokončena práškovou barvou. Na opěradlovou část sedacího nábytku, podnožku i stůlek je použita exteriérová síťovina Batyline. Čalounění je vyrobeno z vysoce kvalitních outdoorových materiálů. Jako doplněk lze zvolit venkovní polštáře.

EN Our Moja modular collection is made of galvanized steel finished with a powder coating. The backrest, footrest, and table are made of Batyline mesh, and the upholstery is made of high-quality, outdoor material. Our exterior pillows make for an ideal accessory.

DE Die modulare Kollektion Moja ist aus einer Stahlkonstruktion hergestellt, die verzinkt und pulverbeschichtet ist. Sowohl die Rückenlehne der Sitzmöbel, als auch der Hocker und der Tisch wurden aus dem Outdoor-Netzgewebe Batyline hergestellt. Die Polsterung ist ebenfalls aus hochwertigen Outdoor-Materialien hergestellt. Als Zubehör können Outdoor-Kissen ausgewählt werden.

PL Modułowa kolekcja jest wykonana ze stali ocynkowanej. Oparcie, podnóżek i stół są wykonane z tapicerki Batyline, który jest z wysokiej jakości materiałem zewnętrznym. Poduszki stanowią idealny dodatek do tej kolekcji.

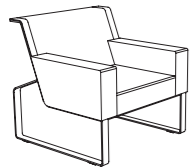

MO110 82 × 80 × 79 cm

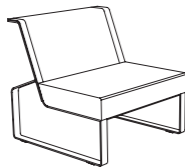

MO115 82 × 80 × 79 cm

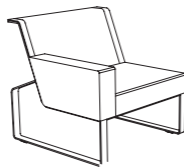

MO116 82 × 80 × 79 cm

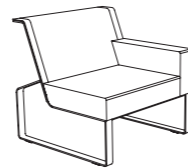

MO117 82 × 80 × 79 cm

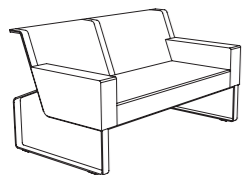

MO120 147 × 80 × 79 cm

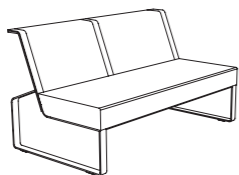

MO125 147 × 80 × 79 cm

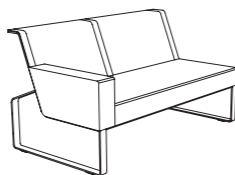

MO126 147 × 80 × 79 cm

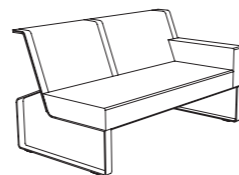

MO127 147 × 80 × 79 cm

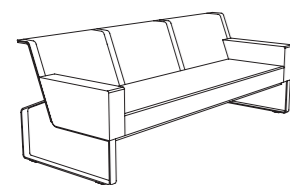

MO130 217 × 80 × 79 cm

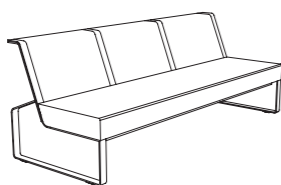

MO135 217 × 80 × 79 cm

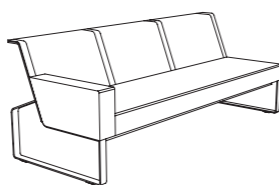

MO136 217 × 80 × 79 cm

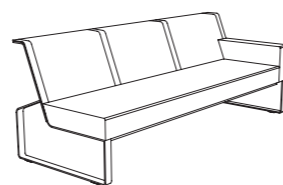

MO137 217 × 80 × 79 cm

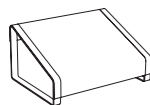

MO200 80 × 59,5 × 41 cm



MO210 82 × 81 × 42 cm

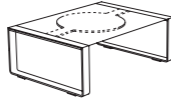

MO300 80 × 60 × 29 cm

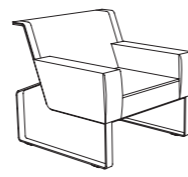

MO1101 82 × 80 × 79 cm

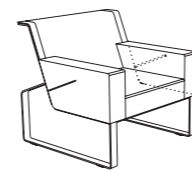

MO1102 82 × 80 × 79 cm

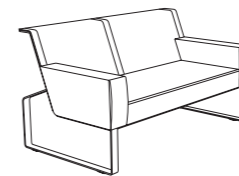

MO1201 147 × 80 × 79 cm

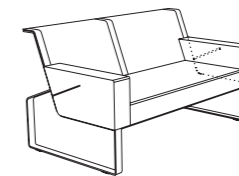

MO1202 147 × 80 × 79 cm

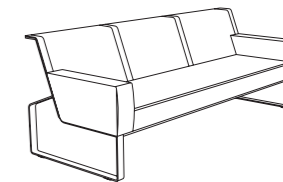

MO1301 217 × 80 × 79 cm

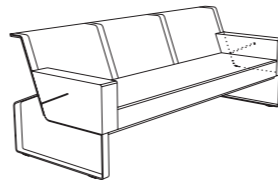

MO1302 217 × 80 × 79 cm

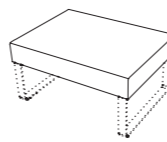

EDO060 82 × 61 × 13 cm

určeno pro
designated for
bestimmt für
przeznaczony dla
MO300



EDO100 55 × 55 cm



EDO101 43 × 43 cm



EDO102 60 × 40 cm



EDO200 55 × 55 cm



EDO201 43 × 43 cm



EDO202 60 × 40 cm

Preva

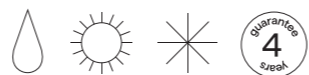

CZ Konstrukce je vyrobena z pozinkovaných pásovin, které jsou povrchově dokončeny práškovou barvou. Sedací i opěradlová část je z tropického dřeva nebo akátu. Křeslo je doplněno o dva podhlavníky z PUR a outdoorové síťoviny Batyline; lze doplnit i o změkčovadla. Z vysokotlakého laminátu (HPL) jsou vyrobeny područky obou křesel.

EN The armchair frame is made of galvanized steel strips finished with a powder coating. The seat and backrest can be made of tropical wood or acacia, and the armrests are made of high pressure laminate (HPL). It comes with two head cushions made of PUR foam and Batyline outdoor mesh, and can be softened with the use of additional accessories.

DE Die Konstruktion wurde aus verzinkten Stahlbändern hergestellt, die pulverbeschichtet sind. Die Sitzfläche sowie Rückenlehne wurde aus tropischem Holz oder Akazienholz hergestellt. Der Sessel wurde mit zwei Kopfstützen aus PUR-Schaum und Outdoor-Batyline ergänzt. Die Armlehnen der beiden Sessel wurden aus Hochdrucklaminat (HPL) hergestellt.

PL Konstrukcja jest wykonana z ocynkowanych stalowych pasków. Siedzisko i oparcie jest wykonane z drewna tropikalnego lub akacji. Uzupełnieniem krzesła są dwa zagłówki wykonane z PUR i siatki zewnętrznej Batyline.



LP355 66,5 × 105 × 77,5 cm



LP375 66,5 × 71 × 81 cm

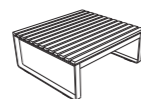

LP365 63,5 × 58,5 × 26,5 cm

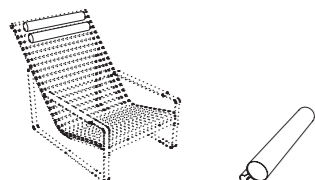

EDO011/012 45, ø 7 cm

Radium

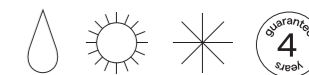

CZ Konstrukce je pro odlehčení vyrobena z hliníkového plechu, který je povrchově dokončený práškovou barvou. Sedací i opěradlová část je vyrobena z tropického dřeva, akátu nebo HPL.

EN Structure made of aluminum sheet with powder coating finish. Seat and backrest made of tropical wood, acacia or HPL.

DE Um die Konstruktion zu erleichtern, wurde sie aus Aluminiumblech hergestellt, welches anschließend oberflächlich mit Pulverfarbe behandelt wurde. Die Sitzplatte und Rückenlehne ist in den Varianten tropisches Holz, Akazienholz oder HPL erhältlich.

PL Konstrukcja wykonana jest z aluminium, która jest pomalowana proszkowo. Siedzisko i oparcie wykonane są z drewna tropikalnego, akacji lub HPL.

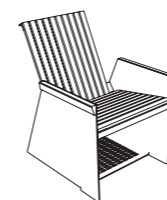

LRE350 60 × 72 × 85 cm

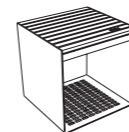

LRE115 45 × 42 × 43 cm



LRE450 45 × 42 × 43 cm

98 ←

Salto

CZ Konstrukce je vyrobena z oceli, která je pozinkovaná a následně povrchově dokončena práškovou barvou. Nohy věšáku a němého sluhu jsou z tropického dřeva nebo akátu.

EN The main part of the furniture is made of zinc-coated steel with a powder coated finish. The legs of the coat rack and the valet stand are made of either tropical wood or acacia.

DE Die Konstruktion wurde aus Stahl hergestellt, welcher verzinkt und anschließend mit Pulverfarbe beschichtet werden. Die Beine sind aus tropischem Holz oder aus Akazienholz.

PL Konstrukcja została wykonana ze stali ocynkowanej malowanej proszkowo. Nogi wykonane są z drewna tropikalnego lub akacjowego.

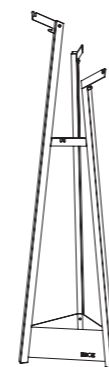

SAL100 50 × 50 × 183 cm



SAL200 57 × 48,5 × 118 cm

104 ←

Sena

CZ Celodřevěné stoly jsou vyrobeny z tropického dřeva, na přání mohou být ošetřeny teakovým olejem. Stolové desky mohou být i ve variantě HPL.

EN Solid wood tables made of tropical wood, may be treated with teak oil upon request. Table tops may be chosen in HPL variant, too.

DE Die hölzernen Tische wurden aus tropischem Holz gefertigt. Auf Wunsch kann die Oberfläche mit Teak-Öl behandelt werden.

PL Stoły z litego drewna wykonane z drewna tropikalnego, na życzenie mogą być pokryte olejem tekowym. Blaty mogą być wybrane również w wariacie HPL.

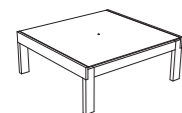
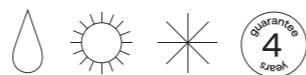

SN121 100 × 106 × 40 cm

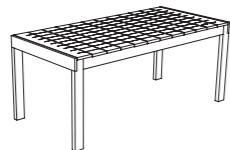

SN100 178,5 × 85 × 75 cm

6-8
😊



SN110 178,5 × 85 × 75 cm

6-8
😊

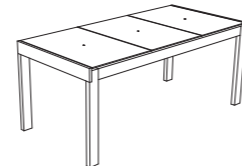

SN120 178,5 × 85 × 75 cm

6-8
😊

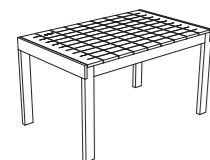

SN102 135 × 85 × 75 cm

4-6
😊

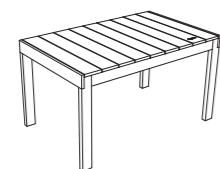

SN112 135 × 85 × 75 cm

4-6
😊

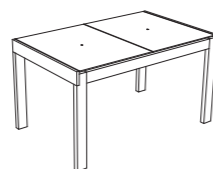

SN122 135 × 85 × 75 cm

4-6
😊

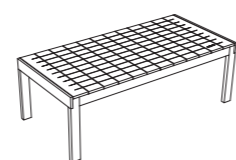

SN103 178,5 × 85 × 60 cm

6-8
😊

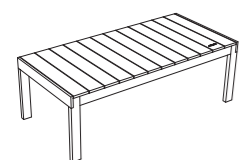

SN113 178,5 × 85 × 60 cm

6-8
😊

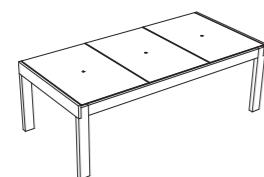

SN123 178,5 × 85 × 60 cm

6-8
😊



SN105 222 × 85 × 75 cm

6-8
😊

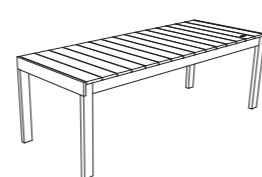

SN115 222 × 85 × 75 cm

6-8
😊

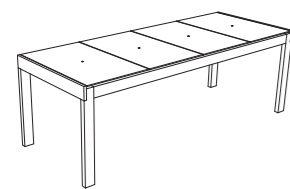

SN125 222 × 85 × 75 cm

6-8
😊

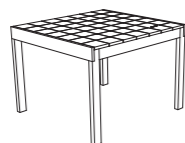

SN106 100 × 106 × 75 cm

4
😊



SN116 100 × 106 × 75 cm

4
😊

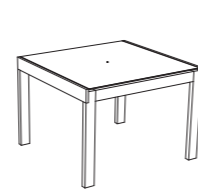

SN126 100 × 106 × 75 cm

4
😊

Sombra

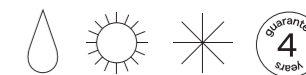

CZ Dřevěná konstrukce je vyráběna z tvrdého a odolného dřeva. Všechny ocelové díly jsou povrchově dokončeny zinkem a práškovou barvou. Velikostní varianty je možné doplnit o zástěny, gril, posuvné dveře, vrata, popínavé rostliny a konzolu.

EN The wooden structure is made of hard and durable wood. All steel parts are surface-finished with zinc and powder coating. You can supplement the available size variants with screens, a grill, a sliding door, a gate, climbing plants and a console.

DE Die Holzkonstruktion wird in hartem und widerstandsfähigem Holz angeboten. Alle Stahlteile sind oberflächlich mit Zink und Pulverfarbe behandelt. Die verschiedenen Größenvarianten können mit einer Schutzwand, einem Grill, einer Schiebetüre, einem Tor, mit Schlingpflanzen oder einer Konsole erweitert werden.

PL Drewniana konstrukcja wykonana jest z twardego i wytrzymałego drewna. Wszystkie części stalowe są ocynkowane i pomalowane proszkowo. Dostępne warianty wielkości można uzupełnić ekranami, grilem, przesuwanymi drzwiami, bramą, roślinami pnącymi.

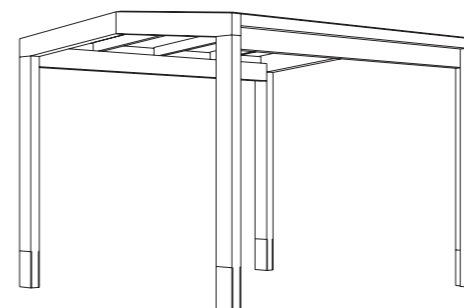

SOD110 320 × 330 × 265 cm

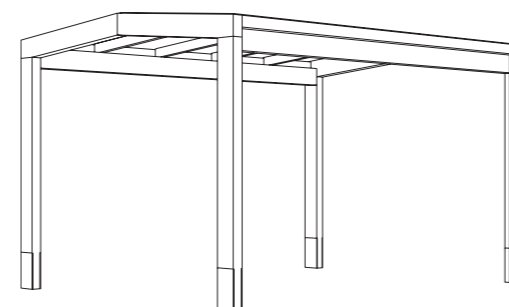

SOD120 320 × 410 × 265 cm

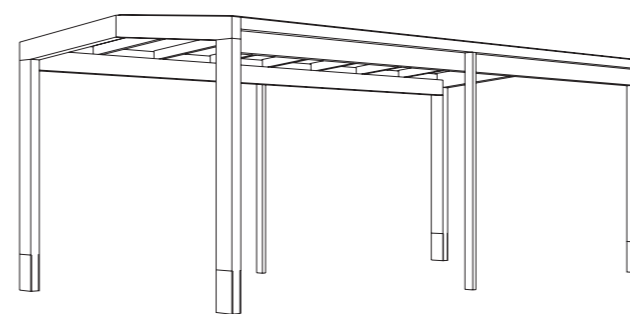

SOD130 320 × 650 × 265 cm

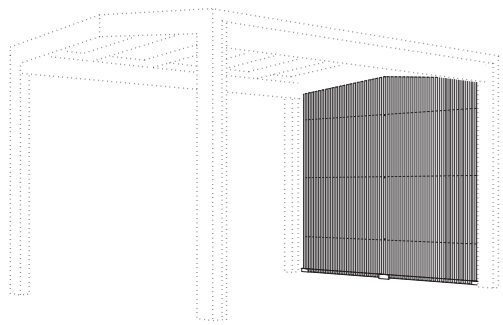

SOD200

270 × 239,5 cm

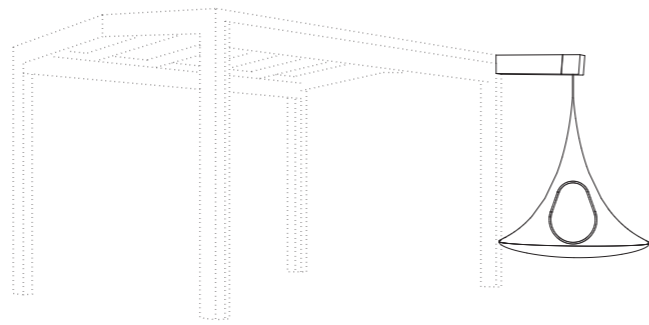

SOD600

Ø 120 cm

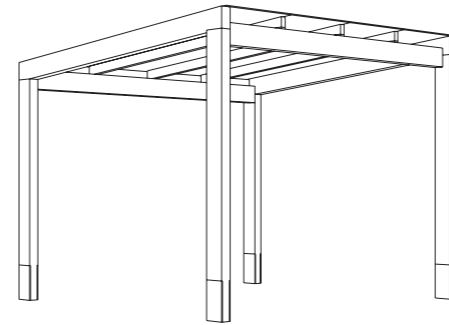

SOP110

320 × 330 × 285 cm

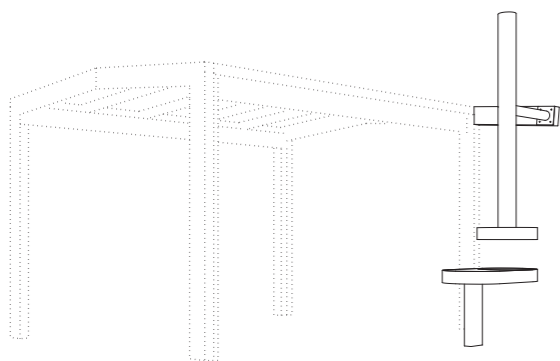

SOD700

120 × 338 cm

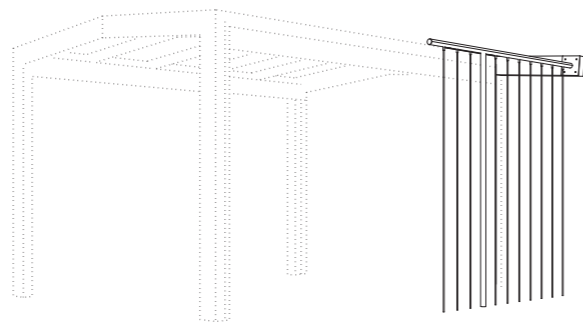

SOD800

235,5 × 261 cm

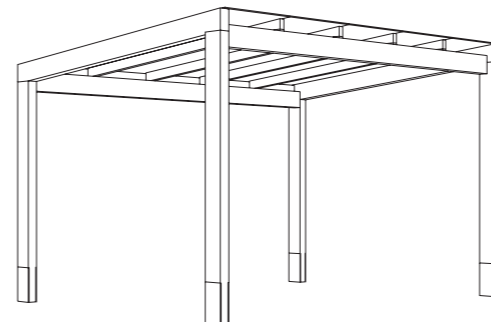

SOP120

320 × 410 × 285 cm

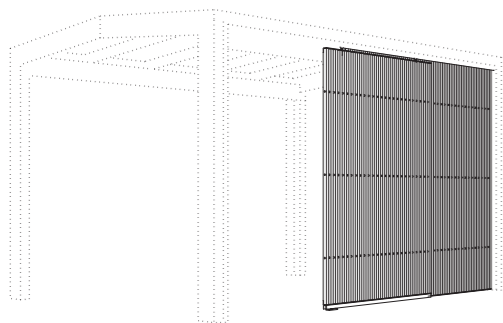

SOD510

300 × 228,5 cm

určeno pro
designated for
bestimmt für
przeznaczone dla
SOD110

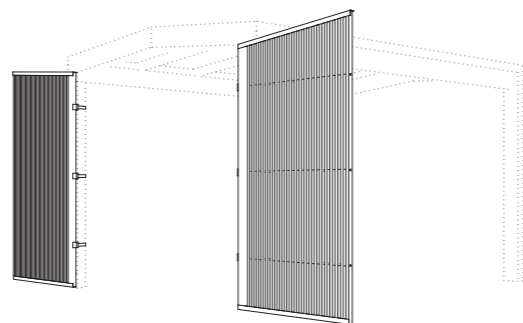

SOD300

270 × 239,5 cm

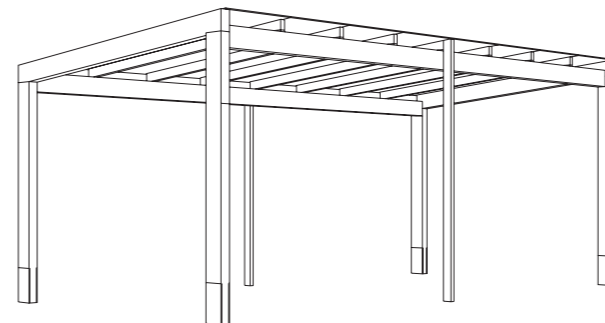

SOP130

320 × 650 × 285 cm

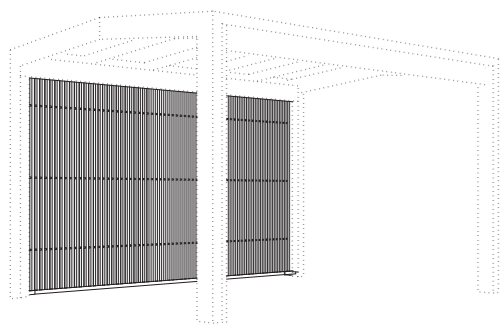

SOD410

294 × 235,5 cm

určeno pro
designated for
bestimmt für
przeznaczone dla
SOD110

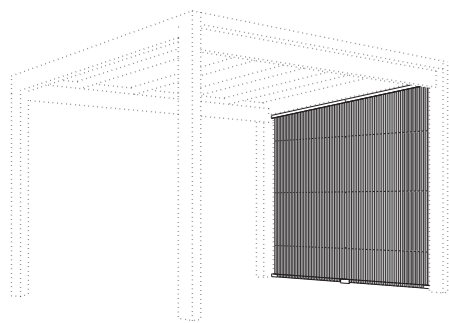

SOP200 270 × 242 cm

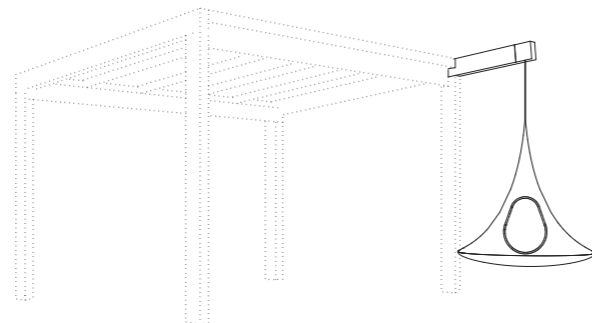

SOP600 Ø 120 cm

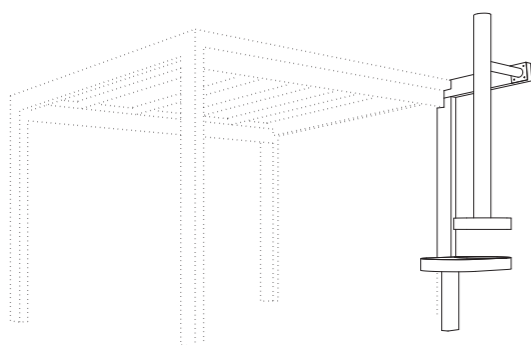

SOP700 120 × 338 cm

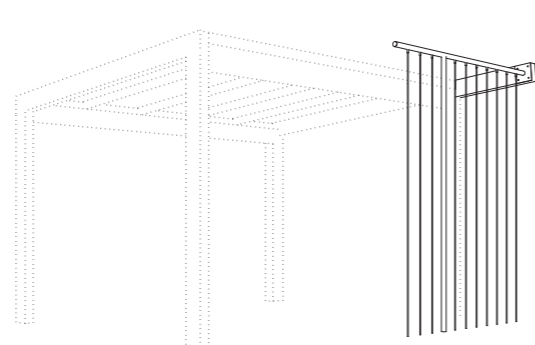

SOP800 235,5 × 281 cm

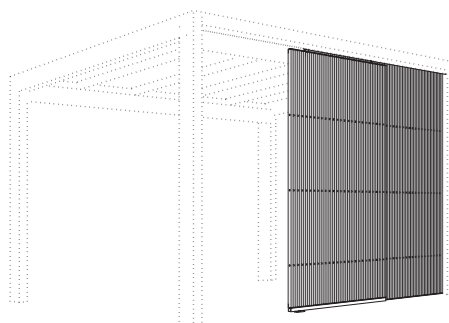

SOP510 300 × 248,5 cm

určeno pro
designated for
bestimmt für
przeznaczone dla
SOP110

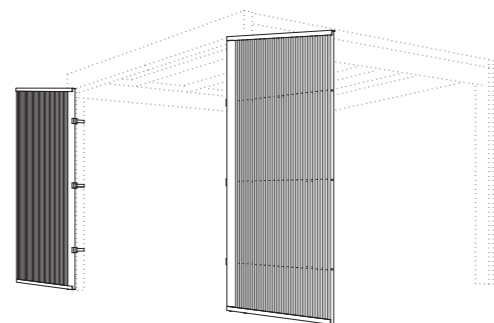

SOP300 270 × 259,5 cm

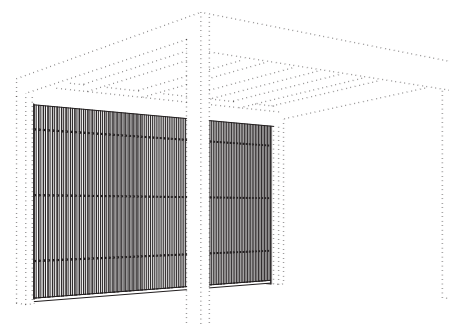

SOP410 294 × 236,5 cm

určeno pro
designated for
bestimmt für
przeznaczone dla
SOP110

Spulka

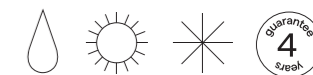

CZ Celooceľová stolička a stoly jsou opatřeny vrstvou žárového zinku a dokončeny práškovou barvou.

EN Steel construction of stool and tables are zinc coated with powder coating finish.

DE Der Ganzstahlhocker und die Tische sind verzinkt und pulverbeschichtet.

PL Stoliki oraz stołki są wykonane ze stali ocynkowanej proszkowo.

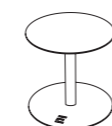

SP110 Ø 45 × 45 cm

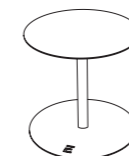

SP210 Ø 60 × 60 cm



SP215 Ø 60 × 75 cm

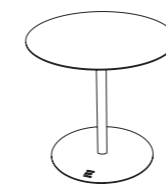

SP310 Ø 80 × 75 cm

4
😊

Štok

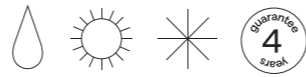

CZ Produkty jsou sestaveny pouze z masivních desek bez spojovacího materiálu. Použity jsou dubové, jasanové nebo akátové dřeviny.

EN The products are assembled from solid wood boards without the use of adhesives. Štok is made from oak, ash or acacia wood.

DE Die Produkte werden nur aus Massivholzplatten ohne Verbindungsmaterial zusammengesetzt. Dazu wird Eichen-, Eschen- oder Akazienholz verwendet.

PL Produkt jest wykonany z litego materiału bez łączeń. Używany w nim jest dąb, jesion lub akacja.

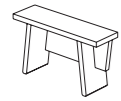

STK110 54 × 16 × 30 cm

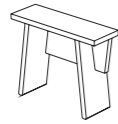

STK120 54 × 18 × 42 cm

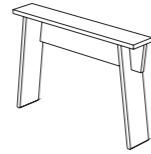

STK610 100 × 18 × 66,5 cm

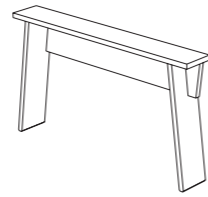

STK620 120 × 18 × 66,5 cm

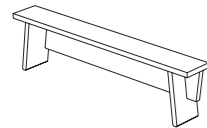

STK210 120 × 16 × 30 cm

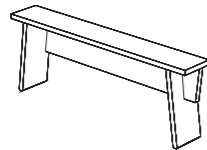

STK220 120 × 18 × 42 cm

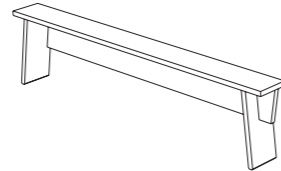

STK230 180 × 18 × 42 cm

Tina

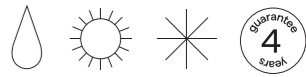

CZ Konstrukce je vyrobena z pozinkovaných trubek a povrchově dokončena práškovou barvou. Varianty sedáků lze zvolit z tropického dřeva, akátu nebo ocelových kulatinek, které lze doplnit outdoorovými pěnovými průplety. Deska stolu je ve variantě tropického dřeva, akátu nebo vysokotlakého laminátu (HPL).

EN Structure made of galvanized steel tubes with powder coating finish. The options for the seating are: tropical wood, acacia or steel rods that can be completed with softeners made of outdoor foam. Table top is made of solid wood, acacia or high pressure laminate (HPL).

DE Die Konstruktion wurde aus verzinkten pulverbeschichteten Stahlrohren hergestellt. Die Tischplatte ist in Tropischem-/ Akazienholz oder in Hochdruckmaterial erhältlich, Rundstahlstäbe eventuell mit verflochtenem Outdoor Schaumstoffstreifen ersetzbar.

PL Konstrukcja jest wykonana z ocynkowanych stalowych elementów. Siedziska można wybierać spośród: drewna tropikalnego, akacji lub stalowych rurek, które można uzupełnić sznurkami z pianki zewnętrznej. Blat w wariacji z drewna tropikalnego, akacji lub laminatu wysokociśnieniowego (HPL).



KL100 49,5 × 56 × 86,5 cm



KL102 49,5 × 56 × 86,5 cm



KL103 49,5 × 56 × 86,5 cm



KL104 53 × 56 × 86,5 cm



KL105 49,5 × 56 × 45 cm



KL106 100 × 100 × 76 cm

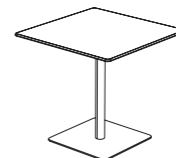

KL117 80 × 80 × 76 cm

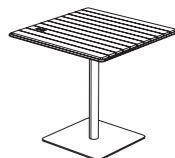

KL116 80 × 80 × 76 cm



EDO021 60 × 5 × 1 cm

déšť / rain / Regen /
deszcz



sluneční záření /
sun rays /
Sonnenschein /
słońce



sníh / snow / Schnee /
śnieg



záruka / warranty /
Garantie / gwarancja



stohovatelnost /
stackable /
Stapelbarkeit /
możliwość ukladania



počet lidí u stolu /
no. of persons at
the table / Anzahl
Personenauswahl am
Tisch. / ilość osób



concept studio 519
design Andrea Vacovská, Zuzana Lednická (Studio Najbrt)
production studio 519
photography Dušan Tománek, Julius Filip,
Jan Ryšavý, Michala Homolová
© 2020

Egoé life s.r.o.
Bílovice 519, 687 12 Bílovice Czech Republic
life@egoe.eu, www.egoe.eu



outdoor furniture
www.egoe.eu